

# Superseded



As of January 13<sup>th</sup>, 2004 the Ethernet Consortia Clause 4 MAC Conformance Test Suite version 4.3 has been superseded by the release of the Ethernet Consortia Clause 4 MAC Conformance Test Suite version 4.4. This document along with earlier versions, are available on the EFM Consortium test suite archive page.

Please refer to the following site for both current and superseded test suites:

<http://www.ioi.unh.edu/testsuites/ge>

# **ETHERNETS**

## **Clause 4 Media Access Control (MAC) Test Suite Version 4.3**

*Technical Document*



Last Updated: July 19, 2004 2:43 PM

---

*Ethernet Testing Services  
Fast Ethernet Consortium  
Gigabit Ethernet Consortium*

*InterOperability Laboratory  
Research Computing Center  
University of New Hampshire*

*121 Technology Drive, Suite 2  
Durham, NH 03824*

*Phone: +1-603-862-0166*

*Fax: +1-603-862-0898*

<http://www.iol.unh.edu/consortiums/10baset/>

<http://www.iol.unh.edu/consortiums/fe>

<http://www.iol.unh.edu/consortiums/ge>

---

*The University of New Hampshire  
InterOperability Laboratory*

## **MODIFICATION RECORD**

- **July 19, 2004 Version 4.3 Released**  
Pete Scruton: Fixed typographical errors, revised various procedures, write-ups, and observable results.
- **June 23, 2004 Version 4.2 Released**  
Mike Henninger: Fix typographical error and expanded discussion in bursting and extension tests.
- **July 8, 2003 Version 4.1 Released**  
Mike Henninger: Revised integrated test suite and add new tests
- **October 10, 2001 Integrated Version 4.0 Released**  
Gerard Nadeau: Integrated all 10Mb/s, 100Mb/s and 1000Mb/s versions into one test suite.
- **January 11, 2000 10BASE-T Version 3.0 Released**  
Neal Starr: Added missing tests from the Fast Ethernet test suite and renumbered test suite.
- **January 10, 2000 Gigabit version 1.1 Released**  
Al Braga: Review test suite and update references to new version of the standard.
- **October 13, 1999 10BASE-T Version 2.0 Released**  
Neal Starr: Added Start of Frame Delimiter Error Reception and Recovery.
- **May 5, 1999 Fast Ethernet Version 3.10 Released**  
Pete Scruton: Fix typographical errors and renumbering tests.
- **January 22, 1999 Fast Ethernet Version 3.01 Released**  
Pete Scruton: Major revision, rewritten and added tests.
- **January 3, 1998 Gigabit Version 1.0 Released**  
Rupert Dance: Released initial version of the Gigabit MAC Test Suite.
- **Date Unknown, Fast Ethernet Version 1.0 Released.**  
Bob Noseworthy: Released initial version of the Fast Ethernet Test Suite.
- **Date Unknown, 10BASE-T Version 1.0 Released**  
Adam Healey: Released initial version of the 10BASE-T Test Suite.

*The University of New Hampshire  
InterOperability Laboratory*

## **ACKNOWLEDGMENTS**

**The University of New Hampshire would like to acknowledge the efforts of the following individuals in the development of this test suite.**

Aldobino Braga	University of New Hampshire
Cindy Bowman	University of New Hampshire
Rupert Dance	University of New Hampshire
Adam Healey	University of New Hampshire
Mike Henninger	University of New Hampshire
Stephen Kelsey	University of New Hampshire
Eric Lynskey	University of New Hampshire
Gerard Nadeau	University of New Hampshire
Bob Noseworthy	University of New Hampshire
Pooja Patel	University of New Hampshire
Peter Scruton	University of New Hampshire
Neal Starr	University of New Hampshire
David Strohschein	University of New Hampshire

## **INTRODUCTION**

### **Overview**

The University of New Hampshire's InterOperability Laboratory (IOL) is an institution designed to improve the interoperability of standards based products by providing an environment where a product can be tested against other implementations of a standard. This suite of tests has been developed to help implementers evaluate the functioning of their Clause 4 Media Access Control (MAC) based products. The tests do not determine if a product conforms to the IEEE 802.3, nor are they purely interoperability tests. Rather, they provide one method to isolate problems within a MAC device. Successful completion of all tests contained in this suite does not guarantee that the tested device will operate with other devices. However, combined with satisfactory operation in the IOL's interoperability test bed, these tests provide a reasonable level of confidence that the Device Under Test (DUT) will function well in most environments.

### **Organization of Tests**

The tests contained in this document are organized to simplify the identification of information related to a test and to facilitate in the actual testing process. Each test contains an identification section that describes the test and provides cross-reference information. The discussion section covers background information and specifies why the test is to be performed. Tests are grouped by similar functions and further organized by technology. Each test contains the following information:

### **Test Number**

The Test Number associated with each test follows a simple grouping structure. Listed first is the Test Group Number followed by the test's number within the group. This allows for the addition of future tests to the appropriate groups of the test suite without requiring the renumbering of the subsequent tests.

### **Purpose**

The purpose is a brief statement outlining what the test attempts to achieve. The test is written at the functional level.

### **References**

The references section lists cross-references to the IEEE 802.3 standards and other documentation that might be helpful in understanding and evaluating the test and results.

### **Resource Requirements**

The requirements section specifies the hardware, and test equipment that will be needed to perform the test. The items contained in this section are special test devices or other facilities, which may not be available on all devices.

### **Last Modification**

This specifies the date of the last modification to this test.

### **Discussion**

The discussion covers the assumptions made in the design or implementation of the test as well as known limitations. Other items specific to the test are covered here.

*The University of New Hampshire  
InterOperability Laboratory*

**Test Setup**

The setup section describes the configuration of the test environment. Small changes in the configuration should be included in the test procedure.

**Procedure**

The procedure section of the test description contains the step-by-step instructions for carrying out the test. It provides a cookbook approach to testing, and may be interspersed with observable results.

**Observable Results**

The observable results section lists specific items that can be examined by the tester to verify that the DUT is operating properly. When multiple values are possible for an observable result, this section provides a short discussion on how to interpret them. The determination of a pass or fail for a certain test is often based on the successful (or unsuccessful) detection of a certain observable result.

**Possible Problems**

This section contains a description of known issues with the test procedure, which may affect test results in certain situations.

## TABLE OF CONTENTS

MODIFICATION RECORD	ii
ACKNOWLEDGMENTS	iii
INTRODUCTION	iv
TABLE OF CONTENTS	vi
LIST OF FIGURES	viii
LIST OF TABLES	ix
LIST OF TABLES	ix
APPLICATION TABLE	x
GROUP 1: Errors During Reception	2
Test #4.1.1 - Reception of frames with FCS errors.	3
Test #4.1.2 - Reception of Fragments and Runts	5
Test #4.1.3 - Reception of Frames Greater than the Maximum Permitted Frame Size	8
Test #4.1.4 - Frames with length errors	11
Test #4.1.5 - Receive Frames with Excess Pad	13
Test #4.1.6 - Jabber Frame Reception and Recovery	15
Test #4.1.7 - Start of Frame Delimiter Error Reception and Recovery	17
Test #4.1.8 - Frames with Alignment Errors	19
Test #4.1.9 - Preamble Error Reception and Recovery	21
GROUP 2: Encapsulation and De-capsulation	23
Test #4.2.1 - Transmit proper Preamble and SFD	24
Test #4.2.2 - Transmission of minimum interFrameGap	26
Test #4.2.3 - Transmit proper length within the Length/Type field	27
Test #4.2.4 - Compute and transmit proper CRC	29
Test #4.2.5 - Receive variable preamble	30
Test #4.2.6 - Receive all Frame Sizes	32
Test #4.2.7 - Reception of minimum interFrameGap	34
Test #4.2.8 - Compute and transmit proper extension	35
Test #4.2.9 - Receive frames with extension	37
GROUP 3: Full Duplex	40
Test #4.3.1 - Does not defer	41
Test #4.3.2 - No collisions	43
Test #4.3.3 - No extension	44
Test #4.3.4 - No bursting	46
GROUP 4: Collision Behavior	48
Test #4.4.1 - Collisions during preamble and SFD within slotTime.	49
Test #4.4.2 - Collisions after the reception of SFD within slotTime	51
Test #4.4.3 - Collisions in data outside of slotTime while not bursting	53
Test #4.4.4 - Collisions during extension within slotTime	55
Test #4.4.5 - Collisions during preamble and SFD outside of slotTime (Burst Mode).	57
Test #4.4.6 - Collisions during data outside of slotTime (Burst Mode)	60
Test #4.4.7 - Collisions during IFG within a Burst	63

*The University of New Hampshire  
InterOperability Laboratory*

GROUP 5: Deference Process	65
Test #4.5.1 - Defer to carrier sense while frame waiting	66
Test #4.5.2 - Deference after collision	68
Test #4.5.3 - Interframe Spacing	70
GROUP 6: Backoff	72
Test #4.6.1 - Retransmission attempt limit	73
Test #4.6.2 - Truncated Binary Exponential BackOff test	75
GROUP 7: Frame Bursting	77
Test #4.7.1 - Interframe Fill	78
Test #4.7.2 - Burst limit	80
Test #4.7.3 - Receive Frame Bursts	82
Test #4.7.4 - Reception of Bursts with an initial frame less than slotTime	84
ANNEX A (informative) Table of Acronym Definitions	87
ANNEX B (informative) Testing Requirements	90
ANNEX C (informative) Suggested Test Setups and Configurations	91
ANNEX D Stressing the device under test (DUT)	93



## LIST OF FIGURES

Figure 4 - 1 Oversized untagged frame .....	9
Figure 4 - 2 Oversized tagged frame .....	9
Figure 4 - 3 An Oversized frame containing a frame of maxFrameSize.....	9
Figure 4 - 4 1000BASE-T PHY Utilizing a MAC/1000BASE-X PCS Combo Chip.....	38
Figure 4 - 5 Does not defer .....	41
Figure 4 - 6 Timing Diagram for Collisions during preamble or SFD.....	50
Figure 4 - 7 Collisions after the reception of SFD within slotTime.....	52
Figure 4 - 8 Collisions in data after slotTime .....	54
Figure 4 - 9 Collisions during extension within slotTime .....	56
Figure 4 - 10 Collisions during preamble and SFD outside of slotTime (Burst Mode).....	58
Figure 4 - 11 Collisions during data outside of slotTime (Burst Mode) .....	61
Figure 4 - 12 Collisions during IFG outside of slot time (Burst Mode).....	64
Figure 4 - 13 Defer to carrier sense while frame waiting.....	67
Figure 4 - 14 Deference after collision.....	69
Figure 4 - 15 Carrier Sense Asserted During IFSP1 .....	71
Figure 4 - 16 Carrier Sense Asserted During IFSP2 .....	71
Figure 4 - 17 Burst limit – Test Case .....	81
Figure 4 - 18 Burst limit – Example Test Cases .....	81
Figure 4 - 19 Test Setup for 10BASE-T Device.....	91
Figure 4 - 20 Test Setup #1 for 100BASE-X Devices .....	91
Figure 4 - 21 Test Setup #2 for 100BASE-X Devices .....	92
Figure 4 - 22 Test Setup #1 for 1000BASE-X Devices .....	92
Figure 4 - 23 Test Setup #2 for 1000BASE-X Devices .....	92
Figure 4 - 24 Test Setup for 1000BASE-T Devices .....	92
Figure 4 - 25 Stressing a Switch .....	93

## LIST OF TABLES

Table 4 - 1 Application of tests to given physical speeds .....	x
Table 4 - 2 Fragment and Runt Test Frames, Part A.....	6
Table 4 - 3 Values of 'm' and 'n', Part A .....	6
Table 4 - 4 Fragment and Runt Test Frames, Part B.....	6
Table 4 - 5 Fragments and Runts Observable Results, Part A.....	7
Table 4 - 6 Fragments and Runts Observable Results, Part B.....	7
Table 4 - 7 Jabber Frames.....	16
Table 4 - 8 Value of 'x' for test 4.2.5.....	20
Table 4 - 9 Acceptable Amounts of Preamble.....	31
Table 4 - 10 Values of "n" for test 4.1.1.....	50
Table 4 - 11 Values of 'n' for test 4.1.2 .....	52
Table 4 - 12 Initial value for "n" for test 4.4.3.....	54
Table 4 - 13 Values for Test 4.5.1.....	66
Table 4 - 14 Values of 'n' and 'x' for Test 4.5.2.....	69
Table 4 - 15 Values for interFrameSpacing Test .....	71
Table 4 - 16 Receive Frame Bursts .....	83
Table 4 - 17 Interpretation of Burst Reception Results .....	83
Table 4 - 18 Reception of Bursts with an initial frame less than slotTime .....	85
Table 4 - 19 Interpretation of Burst Error Reception Results.....	86
Table 4 - 20 Acronym Definitions .....	87

## APPLICATION TABLE

The following table denotes whether or not the listed test is applicable to the given physical layer speed.

**Table 4 - 1 Application of tests to given physical speeds**

<b>Group 1</b>	<b>Errors during Reception</b>	<b>10Mb/s</b>	<b>100Mb/s</b>	<b>1000Mb/s</b>
4.1.1	Reception of Frames with FCS error	√	√	√
4.1.2	Reception of Fragments and Runts	√	√	√
4.1.3	Reception of Frames greater than maxFrameSize	√	√	√
4.1.4	Frames with Length Errors	√	√	√
4.1.5	Receive Frames with Excess Pad	√	√	√
4.1.6	Jabber Frame Reception and Recovery	√	√	√
4.1.7	Start of Frame Delimiter Error Reception and Recovery	√	√	√
4.1.8	Frames with Alignment Errors	√	√	
4.1.9	Preamble Error Reception and Recovery		√	√
<b>Group 2</b>	<b>Encapsulation and De-capsulation</b>			
4.2.1	Transmit proper Preamble and SFD	√	√	√
4.2.2	Transmission of minimum interFrameGap	√	√	√
4.2.3	Transmit proper length within the Length/Type field	√	√	√
4.2.4	Compute and transmit proper CRC	√	√	√
4.2.5	Receive variable preamble	√	√	√
4.2.6	Reception of minimum interFrameGap	√	√	√
4.2.7	Receive all Frames Sizes	√	√	√
4.2.8	Compute and transmit proper extension			√
4.2.9	Receive frames with Extension			√
<b>Group 3</b>	<b>Full Duplex</b>			
4.3.1	Does not defer	√	√	√
4.3.2	No collisions	√	√	√
4.3.3	No extension			√
4.3.4	No bursting			√
<b>Group 4</b>	<b>Collision behavior</b>			
4.4.1	Collision during preamble and SFD within slotTime	√	√	√
4.4.2	Collision after the reception of SFD within slotTime	√	√	√
4.4.3	Collision in data outside of slotTime while not bursting	√	√	√
4.4.4	Collision during extension within slotTime			√

*The University of New Hampshire  
InterOperability Laboratory*

4.4.5	Collision during preamble and SFD outside of slotTime (Burst Mode)			√
4.4.6	Collision during data outside of slotTime (Burst Mode)			√
4.4.7	Collision during IFG within a burst			√
<b>Group 5 Deference Process</b>				
4.5.1	Defer to carrier sense while frame waiting	√	√	√
4.5.2	Deference after collision	√	√	√
4.5.3	Interframe Spacing	√	√	√
<b>Group 6 Backoff</b>				
4.6.1	Retransmission attempt limit	√	√	√
4.6.2	Truncated Binary Exponential BackOff test	√	√	√
<b>Group 7 Frame Bursting</b>				
4.7.1	InterFrame Fill			√
4.7.2	Burst Limit			√
4.7.3	Receive Frame Busts			√
4.7.4	Reception of Bursts with an initial frame less than slotTime			√

## **GROUP 1: Errors During Reception**

**Scope:** The following tests cover MAC operations specific to reception of frames with errors.

**Overview:** These tests are designed to verify that the device under test properly discards frames with errors and reports these errors if possible. The MAC functions explored are defined in Clause 4 of IEEE 802.3.

### **Test #4.1.1 - Reception of frames with FCS errors.**

**Purpose:** To verify that the device under test (DUT) detects frames with frame check sequence (FCS) errors and reports a frameCheckError.

#### **References:**

- [1] IEEE Std 802.3, 2002 Edition - subclauses 3.2.8, 4.2.3.1.2 and 4.2.4.1.2
  - (a) 10Mb/s: - 4.4.2.1
  - (b) 100BASE-X: - 4.4.2.3, 22.2.1.5
  - (c) 1000BASE-X: - 4.4.2.4, 35.2.1.5
  - (d) 1000BASE-T: - 4.4.2.4, 35.2.1.5
- [2] ANNEX A (informative) Table of Acronym Definitions
- [3] ANNEX B (informative) Testing Requirements
- [4] ANNEX C (informative) Suggested Test Setups and Configurations

#### **Resource Requirements:**

- A testing station capable of transmitting frames with arbitrary values in the FCS field and capable of monitoring traffic from the DUT.

**Last Modification:** July 14, 2004

**Discussion:** A CRC is used by the transmit and receive algorithms to detect any errors generated during the transmission of the frame. The FCS field contains a 4-octet (32-bit) CRC value generated by the transmit algorithm. This value is computed as a function of the contents of the destination address, source address, length/type, LLC data and pad (that is, all fields except the preamble, SFD, and FCS). The receiving MAC sublayer collects bits from the reconciliation layer or the PLS layer. One of the receiving MAC sublayer's functions is to check for invalid MAC frames by checking the Frame Check Sequence (FCS) field. It does so by computing the 32-bit CRC of the received frame and comparing it to the received 32-bit CRC in the FCS field. In the case of a mismatch, it should reject the frame.

**Test Setup:** Connect the device under test (DUT) to the testing station with the appropriate medium (i.e. unshielded twisted pair (UTP), shielded twisted pair (STP), balanced copper, multi-mode fiber, etc.) and transmit a valid frame to the DUT to ensure that the DUT is functioning properly. See Annex C for suggested test configurations.

#### **Procedure:**

##### *Part A:*

1. The testing station is instructed to transmit a frame with an incorrect 32-bit CRC value in the FCS field. The output and statistics of the DUT are observed.

##### *Part B:*

1. The testing station is instructed to transmit a frame with an incorrect 32-bit CRC value in the FCS field. This frame should be preceded and followed by a valid frame separated by minimum interFrameGap. The output and statistics of the DUT are observed.

*The University of New Hampshire  
InterOperability Laboratory*

**Observable results:**

- a. The DUT shall detect and discard the frame with an invalid value in the FCS field, and, if clause 30 is implemented, log an FCS error.
- b. The reception of test frames with invalid FCS fields should not affect the reception of the valid request frames.

**Possible Problems:** None

## **Test #4.1.2 - Reception of Fragments and Runts**

**Purpose:** To verify that the device under test (DUT) discards collision fragments.

### **References:**

- [1] IEEE Std 802.3, 2002 Edition, subclauses 4.2.3.3 and 4.2.4.2.2, 4.2.9: *process* BitReceiver, *process* SetExtending, and *procedure* ReceiveLinkMgmt
- [2] ANNEX A (informative) Table of Acronym Definitions
- [3] ANNEX B (informative) Testing Requirements
- [4] ANNEX C (informative) Suggested Test Setups and Configurations

### **Resource Requirements:**

- A testing station capable of transmitting fragments and capable of monitoring traffic from the DUT.

**Last Modification:** July 14, 2004

**Discussion:** At speeds less than or equal to 100Mb/s and at 1000Mb/s in full duplex mode, frames less than 64 bytes in length are considered to be fragments. At 1000Mb/s, in half-duplex and non-burst mode, a frame less than 512 bytes in length is considered to be a fragment and, in half-duplex and burst mode, the first frame must be at least 512 bytes and following frames must be at least 64 bytes.

The MAC should discard these collision fragments. Since occasional collisions are a normal part of Media Access management procedure in half duplex mode, the discarding of such a fragment is not reported as an error.

A “runt” refers to a frame that has a valid 32-bit CRC value but is less than the minFrameSize for 10Mb/s, 100Mb/s and 1000Mb/s in full duplex mode, or slotTime for 1000Mb/s in half duplex mode. The MAC layer should detect and discard runts because they are less than minFrameSize in length.

**Test Setup:** Connect the device under test (DUT) to the testing station with the appropriate medium (i.e. unshielded twisted pair (UTP), shielded twisted pair (STP), balanced copper, multi-mode fiber, etc.) and transmit a valid frame to the DUT to ensure that the DUT is functioning properly. See Annex C for suggested test configurations.

### **Procedure:**

*Part A:*

1. The testing station is instructed to transmit Test Frame 1 with current value of ‘m’, which has the initial value of zero. The output and statistics of the DUT are observed.
2. Ideally, step 1 should be repeated for test frames 1 through 4, given in table Table 4 - 2, with all values of ‘m’ and ‘n’ as indicated in Table 4 - 3.



*The University of New Hampshire  
InterOperability Laboratory*

**Table 4 - 2 Fragment and Runt Test Frames, Part A**

	<b>10/100 Mb/s</b>	<b>1000 Mb/s</b>	<b>Description</b>
<b>1</b>	√	√	A fragment (1 + 'm') bytes in length
<b>2</b>	√	√	A runt frame (42 + 'n') bytes in length
<b>3</b>		√	A fragment (1 + 'm') bytes in length extended to 512 bytes
<b>4</b>		√	A runt frame (42 + 'n') bytes in length extended to 512 bytes

**Table 4 - 3 Values of 'm' and 'n', Part A**

<b>PHY SPEED</b>	<b>Initial value of 'm' and 'n'</b>	<b>Maximum value of 'm'</b>	<b>Maximum value of 'n'</b>
≤ 10Mb/s	'm' = 0 'n' = 0	62 bytes	21 bytes
100Mb/s			
1000Mb/s		510 bytes	469 bytes

*Part B:*

1. The testing station is instructed to transmit Test Frame 5 to the DUT. The output and statistics of the DUT are observed.
2. Step 1 is repeated for each of the applicable Test Frames 5 through 12.

**Table 4 - 4 Fragment and Runt Test Frames, Part B**

	<b>10/100 Mb/s</b>	<b>1000M b/s</b>	<b>Description</b>
<b>5</b>	√	√	7 octets of preamble
<b>6</b>	√	√	7 octets of preamble and SFD
<b>7</b>	√	√	7 octets of preamble, SFD and the MAC destination address of the DUT
<b>8</b>	√	√	7 octets of preamble, SFD, the MAC destination address of the DUT, and an arbitrary source address
<b>9</b>		√	6 octets of preamble, SFD, and a 511 byte runt
<b>10</b>		√	A burst frame, consisting of a properly encapsulated valid 512 byte request frame, 12 bytes of extension (IFG), a 42 byte runt, 12 bytes of extension (IFG), and a valid 64 byte request frame.
<b>11</b>		√	A burst frame, consisting of a 42-byte runt, 12 bytes of extension (IFG) and a 511-byte frame. This combination satisfies slotTime.*
<b>12</b>		√	A frame, consisting of a properly encapsulated, 64 byte request frame with valid checksums and 32-bit CRC fields, extended 511 bytes.

\*These test frames are only valid in Full Duplex mode.

*Part C:*

1. Repeat *Parts A* and *B* with each test frame preceded and followed by a valid frame, separated by a minimum interFrameGap. The output and statistics of the DUT are observed.

**Observable Results:**

*The University of New Hampshire  
InterOperability Laboratory*

The DUT should process each test frame as indicated in Table 4 - 5 and Table 4 - 6. The reception of the test frames should not affect the reception of the valid frames.

*Part A:*

**Table 4 - 5 Fragments and Runts Observable Results, Part A**

Test Frame	10/100Mb/s		1000Mb/s	
	Half Duplex	Full Duplex	Half Duplex	Full Duplex
1	Discard	Discard	Discard	Discard
2	Discard	Discard	Discard	Discard
3	N/A	N/A	Discard	Discard
4	N/A	N/A	Discard <sup>1</sup>	Discard <sup>2</sup>

1. A 511 byte runt with 8 bytes of combined preamble and SFD will be accepted by a 1000BASE-X device due to the nature of the EPD (/T/R/R/) which is also considered part of carrier extension.
2. Each test frame should be discarded if it is less than 64 bytes in length, but it should be accepted if the frame is 64 bytes or greater.

*Part B:*

**Table 4 - 6 Fragments and Runts Observable Results, Part B**

Test Frame	10/100Mb/s		1000Mb/s	
	Half Duplex	Full Duplex	Half Duplex	Full Duplex
5	Discard	Discard	Discard	Discard
6	Discard	Discard	Discard	Discard
7	Discard	Discard	Discard	Discard
8	Discard	Discard	Discard	Discard
9	N/A	N/A	Discard	Accept
10	N/A	N/A	Discard the 42-byte frame. Accept all others.	Discard 42-byte frame. Accept all others.
11	N/A	N/A	Discard both frames	Discard the 42-byte runt. Accept 511-byte frame
12	N/A	N/A	Discard	Accept

*Part C:*

1. The reception of test frames should not affect the reception of the valid frames.

**Possible Problems:** None

### **Test #4.1.3 - Reception of Frames Greater than the Maximum Permitted Frame Size**

**Purpose:** To verify that the device under test (DUT) is tolerant of frames greater than maxFrameSize. The DUT should detect frames greater than maxFrameSize and should report a frameTooLong error to the LLC sublayer.

#### **References:**

- [1] IEEE Std 802.3, 2002 Edition - subclauses 3.2, 3.5, 4.2.9, 4.2.4.2.1, 4.4.2, 41.2.1.7, and 41.2.2.1.4
- [2] ANNEX A (informative) Table of Acronym Definitions
- [3] ANNEX B (informative) Testing Requirements
- [4] ANNEX C (informative) Suggested Test Setups and Configurations

#### **Resource Requirements:**

- A testing station capable of transmitting frames greater than maximum permitted frame size and capable of monitoring traffic from the DUT.

**Last Modification:** July 14, 2004

**Discussion:** The maxUntaggedFrameSize is defined as being 1518 bytes. Any untagged frame containing more than 1518 bytes is presumed to be sourced from a malfunctioning station or the result of a line fault. As specified in 4.2.4.2.1, enforcement of the frame size limit by the receiving device is not required. The receiving device is allowed to truncate frames longer than maxUntaggedFrameSize and report this event as an implementation dependant error.

If a device supports VLAN tagging, the maximum length for tagged frames is maxUntaggedFrameSize + qTagPrefixSize (or 1522 bytes). Any tagged frame containing more than 1522 bytes is presumed to be sourced from a malfunctioning station or the result of a line fault. As specified in clause 4.2.4.2.1, enforcement of the frame size limit by the receiving device is not required. The receiving device is allowed to truncate frames longer than (maxUntaggedFrameSize + qTagPrefixSize) and report this event as an implementation dependant error.

Reception of frames greater than maxFrameSize should not affect the reception of properly encapsulated frames occurring a minimum interFrameGap before and after the large frame.

**Test Setup:** Connect the device under test (DUT) to the testing station with the appropriate medium (i.e. unshielded twisted pair (UTP), shielded twisted pair (STP), balanced copper, multi-mode fiber, etc.) and transmit a valid frame to the DUT to ensure that the DUT is functioning properly. See Annex C for suggested test configurations.

#### **Procedure:**

##### *Part A:*

1. The testing station is instructed to transmit an oversized untagged frame (Figure 4 - 1) with 'n' equal to 1.
2. The testing station is instructed to increment 'n' by 1 and retransmit the frame until the DUT is observed to discard or truncate the test frame.

*The University of New Hampshire  
InterOperability Laboratory*



**Figure 4 - 1 Oversized untagged frame**

*Part B:*

1. The testing station is instructed to transmit an oversized tagged frame (Figure 4 - 2) with 'n' equal to 1.
2. The testing station is instructed to increment 'n' by 1 and retransmit the frame until the DUT is observed to discard or truncate the test frame.



**Figure 4 - 2 Oversized tagged frame**

*Part C:*

1. The value of 'n' is set to 0. The testing station is then instructed to transmit a 1522 byte frame containing a valid 1518 byte frame as illustrated in
2. Figure 4 - 3. The FCS field should contain a valid CRC for the entire frame including the 1518 byte frame.
3. The testing station is instructed to increment the value of 'n' by 1, to make a frame 1522 + 'n' bytes in length. This is repeated until the size of the frame is equal to 1540 bytes.
4. If the DUT truncated and responded to these test frames and discarded the test frames in Part A then repeat parts 1 and 2 with an invalid CRC value in the final 4 bytes of the frame. Bytes 1515 – 1518 should still contain a valid CRC for the preceding bytes.

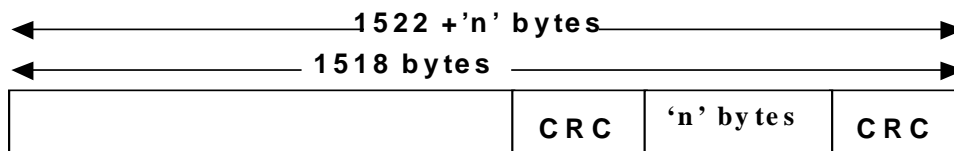

**Figure 4 - 3 An Oversized frame containing a frame of maxFrameSize**

*Part D:*

1. *Parts A through C* are repeated with the test frame preceded and followed by a valid frame, separated by minimum interFrameGaps (96 bit-times).

**Observable Results:**

- a. The DUT may discard any untagged frame larger than the maxUntaggedFrameSize of 1518 bytes. The DUT may not transmit untagged frames, in response to the test frame, greater than maxUntaggedFrameSize. The DUT may optionally log the test frames as frameTooLong errors.
- b. The DUT may discard any tagged frame larger than the maxUntaggedFramesSize and the qTagPrefixSize combined (1522 bytes). The DUT may not transmit tagged frames, in

*The University of New Hampshire*  
*InterOperability Laboratory*

response to the test frame, greater than  $\text{maxUntaggedFrameSize} + \text{qTagPrefixSize}$ . The DUT may optionally log the test frames as `frameTooLong` errors.

- c. The DUT should discard or truncate and respond to the test frames containing two CRC values. The DUT shall not transmit, untagged frames greater than 1518 bytes in length. If the DUT accepted these test frames and discarded the test frames of the same size in part A, then the DUT must truncate and respond to the test frames of the same size with a valid CRC value in bytes 1515 – 1518 and an invalid CRC in the last 4 bytes of the frame. (Otherwise this would indicate that the DUT improperly checked the CRC value twice, once before truncation and once after.) The DUT may optionally log the test frames as `frameTooLong` errors.
- d. The reception of test frames should not affect the reception of valid frames preceding or following the test frame.

**Possible Problems:**

- If the DUT supports a proprietary frame size (Jumbo frames) greater than the maximum permitted frame size, it should be disabled before this test is performed.

#### **Test #4.1.4 - Frames with length errors**

**Purpose:** To verify that the device under test (DUT) detects frames with length errors and reports a lengthError to the LLC sublayer.

#### **References:**

- [1] IEEE Std 802.3, 2002 edition- subclauses 3.2.6, 3.2.7, 4.3.2, 4.2.8, 4.2.9
- [2] ANNEX A (informative) Table of Acronym Definitions
- [3] ANNEX B (informative) Testing Requirements
- [4] ANNEX C (informative) Suggested Test Setups and Configurations

#### **Resource Requirements:**

- A testing station capable of transmitting frames with invalid length values in the length/type field and capable of monitoring traffic from the DUT.

**Last Modification:** July 14, 2004

**Discussion:** When receiving a frame, the MAC layer of the receiving station interprets the value of the 2-octet long Length/Type field of the frame. If the value in the Length/Type field is greater than or equal to 1536 then the value indicates the type of the frame, or if the value in the field is less than or equal to 1500 then the value indicates the length of the frame. All other values are undefined.

If the value in the Length/Type field indicates a length but the length indicated is less than the minimum required for proper operation of the protocol (46 bytes), then Pad will be added at the end of the Data/Pad field but prior to the FCS field.

When the MAC sublayer receives a frame, the *function* ReceiveDataDecap verifies that the length matches the length of the data field. If the length indicated in the Length/Type field is less than the length of the data field, the extra is assumed to be pad and removed. If the length indicated in the Length/Type field is greater than the length of the data field, then the frame is identified as having a length error.

**Test Setup:** Connect the device under test (DUT) to the testing station with the appropriate medium (i.e. unshielded twisted pair (UTP), shielded twisted pair (STP), balanced copper, multi-mode fiber, etc.) and transmit a valid frame with an appropriate length in the Length/Type field to the DUT to ensure that the DUT is functioning properly. See Annex C for suggested test configurations.

#### **Procedure:**

##### *Part A:*

1. The testing station is instructed to transmit a 64-byte frame with the value of 0x002F in the length field; this value is the length of the Data/Pad field plus one.
2. The value in the Length/Type field is then incremented by 1 and the test frame is retransmitted until the value is equal to 0x05FF.
3. Once the value in the Length/Type field is equal to 0x05FF then the size of the frame is incremented by 1 and the value of the Length/Type field is set to the length of the Data/Pad field plus one. The test frame is then retransmitted.

*The University of New Hampshire*  
*InterOperability Laboratory*

4. Ideally, steps 2 and 3 are repeated until frame size is equal to 1518 bytes in length. Typically, 2 or 3 lengths are tested for 2 or 3 different frame sizes.

*Part B:*

1. *Part A* is repeated with the test frames preceded and followed by a valid frame, separated by minimum interFrameGaps (96 bit-times).

**Observable results:**

- a. The DUT should detect and discard the frames with invalid lengths in the Length/Type field. The DUT may optionally log the test frames as aInRangeLengthErrors.
- b. The reception of test frames should not affect the reception of the valid request frames.

**Possible Problems:** None

### **Test #4.1.5 - Receive Frames with Excess Pad**

**Purpose:** To verify that the device under test (DUT) accepts frames that are greater than minimum frame size in length and which contain pad.

#### **References:**

- [1] IEEE Std 802.3, 2002 edition- subclauses 3.2.6, 3.2.7, 4.3.2, 4.2.8, 4.2.9, *function RemovePad*
- [2] ANNEX A (informative) Table of Acronym Definitions
- [3] ANNEX B (informative) Testing Requirements
- [4] ANNEX C (informative) Suggested Test Setups and Configurations

#### **Resource Requirements:**

- A testing station capable of transmitting frames with excess pad and capable of monitoring traffic from the DUT.

**Last Modification:** April 21, 2003

**Discussion:** When receiving a frame, the MAC layer of the receiving station interprets the value of the 2-octet long Length/Type field of the frame. If the value in the Length/Type field is greater than or equal to 1536 then the value indicates the type of the frame, or if the value in the field is less than or equal to 1500 then the value indicates the length of the frame. All other values are undefined.

If the value in the Length/Type field indicates a length but the length indicated is less than the minimum required for proper operation of the protocol (46 bytes), then pad will be added at the end of the Data/Pad field but prior to the FCS field. It has been demonstrated that some devices add pad to frames that contain data greater than the minimum required for proper operation of the protocol. This behavior should not effect the reception of the frame, as described below.

When the MAC sublayer receives a frame, the *function* ReceiveDataDecap verifies that the length matches the length of the data field. If the length indicated in the Length/Type field is less than the length of the data field, then the extra is assumed to be pad and is removed.

**Test Setup:** Connect the device under test (DUT) to the testing station with the appropriate medium (i.e. unshielded twisted pair (UTP), shielded twisted pair (STP), balanced copper, multi-mode fiber, etc.) and transmit a valid frame to the DUT to ensure that the DUT is functioning properly. See Annex C for suggested test configurations.

#### **Procedure:**

##### *Part A:*

1. The testing station is instructed to transmit a 65 byte frame with the value of 0x2E in the length/type field, thus the frame will contain 46 bytes of data and 1 byte of pad.
2. The length of the frame incremented by one and the test frames is retransmitted until the length of the frame is equal to 1518 bytes in length.
3. Once the frame is equal to 1518 bytes in length the value of Length/Type field is incremented by one and the length of the Data/Pad is set equal to the value in the Length/Type plus one. The test frame is retransmitted.



*The University of New Hampshire*  
*InterOperability Laboratory*

4. Ideally, steps 1 through 3 are repeated such that each possible length value is tested for each possible frame size. Typically, a few length values are tested for a few different frame sizes.

*Part B:*

1. *Part A* is repeated with the test frames preceded and followed by a valid frame, separated by minimum interFrameGaps (96 bit times).

**Observable results:**

- a. The DUT should accept each test frame and reply with a frame that does not contain padding.
- b. The reception of test frames should not affect the reception of the valid request frames.

**Possible Problems:** None

### **Test #4.1.6 - Jabber Frame Reception and Recovery**

**Purpose:** To verify that the device under test (DUT) is able to withstand and recover from the reception of worst-case jabber transmissions.

#### **References:**

- [1] IEEE Std 802.3, 2002 Edition - subclauses 4.2.4.2.1, 4.2.9
  - (a) 10Mb/s: - 4.4.2.1, 9.6.5, 14.2.1.6
  - (b) 100BASE-X: - 4.4.2.3, 27.3.2.1.4, Figure 27-7 Receive timer state diagram for port X
  - (c) 1000BASE-X: - 4.4.2.4, 41.2.2.1.4, Figure 41-3 Receive timer state diagram for port X
- [2] ANNEX A (informative) Table of Acronym Definitions
- [3] ANNEX B (informative) Testing Requirements
- [4] ANNEX C (informative) Suggested Test Setups and Configurations

#### **Resource Requirements:**

- A testing station capable of transmitting extremely large frames and capable of monitoring traffic from the DUT.

**Last Modification:** January 27, 2003

**Discussion:** Jabber refers to a data transmission by the physical layer for an abnormal period of time. Two functions of a repeater's physical layer, MAU or PMA, are to determine whether a stream of data is abnormally long and to interrupt it. An abnormally long stream of data is defined as 20 to 150ms at 10Mb/s, 40,000 to 75,000 bitTimes at 100Mb/s, and 80,000 to 150,000 bitTimes at 1000Mb/s.

**Test Setup:** Connect the device under test (DUT) to the testing station with the appropriate medium (i.e. unshielded twisted pair (UTP), shielded twisted pair (STP), balanced copper, multi-mode fiber, etc.) and transmit a valid frame to the DUT to ensure that the DUT is functioning properly. See Annex C for suggested test configurations.

#### **Procedure:**

##### *Part A:*

1. The testing station is instructed to transmit a frame maximum jabber size in length, for each jabber size defined for each MAC speed, consisting of 7 bytes of preamble, one byte of SFD and appropriate number of bytes of Data.

##### *Part B:*

1. The testing station is instructed to transmit each test frame preceded by a valid frame separated by minimum IFG and followed by another valid frame separated by the minimum recovery time (as specified in Table 4 - 7).

**Table 4 - 7 Jabber Frames**

	<b>Maximum Jabber size</b>	<b>Minimum recovery time</b>
<b>10Mb/s*</b>	187492 bytes	.25 sec
<b>10/100Mb/s</b>	9367 bytes	96 bit times
<b>1000Mb/s</b>	18742 bytes	96 bit times

\*MAU lockout time.

**Observable Results:**

- a. The DUT should discard the jabber frame and may log a frameTooLong error if clause 30 management is implemented.
- b. The reception of the jabber frame should not interfere with reception of valid MAC frames. All frames preceding and following the test frames should be properly replied to.

**Possible Problems:**

- **100BASE-TX:** Even though the maximum jabber frame is defined to be a 75000-bit frame, an issue may occur before this maximum number of bits can be transmitted to the DUT. The receive descrambler of the DUT may lose synchronization during the reception of a jabber frame. Typically this can happen when more than 36100 bits are received without at least receiving 29 consecutive plaintext idle pattern bits. Refer to the ANSI X3T9.5 TP-PMD standard in section 7.2.3.3 "Loss of Synchronization".

### **Test #4.1.7 - Start of Frame Delimiter Error Reception and Recovery**

**Purpose:** To verify that the device under test (DUT) discards frames which do not contain a valid Start of Frame Delimiter (SFD).

#### **References:**

- [1] IEEE Std 802.3, 2002 Edition - subclause 3.2.2, 4.2.6, 4.2.9
- [2] ANNEX A (informative) Table of Acronym Definitions
- [3] ANNEX B (informative) Testing Requirements
- [4] ANNEX C (informative) Suggested Test Setups and Configurations

#### **Resource Requirements:**

- A testing station capable of transmitting arbitrary bit patterns in place of the SFD and capable of monitoring traffic from the DUT.

**Last Modification:** July 14, 2004

**Discussion:** The SFD, consisting of the bit pattern 10101011, immediately following the preamble pattern and immediately preceding the destination address indicates the Start of Frame. In order for a frame to be correctly interpreted by the MAC sublayer, a completely formed SFD must be passed across the AUI, MII or GMII. The PhysicalSignalDecap receives one bit at a time until a valid SFD is detected and discards all bits before SFD. Upon reception of the SFD, the PhysicalSignalDecap begins passing successive bits to RecieveLinkMgmt for passing to the LLC sublayer. If there is no SFD following preamble or, if the SFD is invalid, the MAC layer shall not accept the frame.

**Test Setup:** Connect the device under test (DUT) to the testing station with the appropriate medium (i.e. unshielded twisted pair (UTP), shielded twisted pair (STP), balanced copper, multi-mode fiber, etc.) and transmit a valid frame to the DUT to ensure that the DUT is functioning properly. See Annex C for suggested test configurations.

#### **Procedure:**

##### *Part A:*

1. The testing station is instructed to transmit an otherwise valid frame, where the SFD is replaced by another byte of preamble (bit pattern 10101010).
2. The output and statistics of the DUT are observed.

##### *Part B:*

1. The testing station is instructed to transmit an otherwise valid frame, with the bit pattern 10011011 in place of the SFD.
2. The output and statistics of the DUT are observed.

##### *Part C:*

1. *Parts A* and *B* are repeated with each test frame preceded and followed by a valid frame, each separated by a minimum interFrameGap.

*The University of New Hampshire  
InterOperability Laboratory*

**Observable Results:**

- a. The DUT should discard the Test Frame.
- b. The DUT should discard the Test Frame.
- c. The reception of the test frame should not interfere with the reception of valid frames.

**Possible Problems:** None

*The University of New Hampshire*  
*InterOperability Laboratory*

### **Test #4.1.8 - Frames with Alignment Errors**

**Purpose:** To verify that the device under test (DUT) detects and discards frames with alignment errors.

**References:**

- [1] IEEE Std 802.3, 2002 Edition - subclauses 3.4, 4.2.4.2.1, 4.2.9 - *function* ReceiveData Decap,
  - (a) 10Mb/s: - 7.2.2.1.3, 22.2.1.2.1 - Figure 22-3, 22.2.3.5
  - (b) 100BASE-X: - 22.2.1.2.1 - Figure 22-3, Figure 24-4, 22.2.3.5, 24.2.4.4.4, Figure 24-11
- [2] ANNEX A (informative) Table of Acronym Definitions
- [3] ANNEX B (informative) Testing Requirements
- [4] ANNEX C (informative) Suggested Test Setups and Configurations

**Resource Requirements:**

- A testing station capable of transmitting frames that are not an integer number of octets and capable of monitoring traffic from the DUT.

**Last Modification:** January 27, 2003

**Discussion:** Since the format of a valid frame specifies an integer number of octets, at operating speeds less than or equal to 100Mb/s only a collision or an error can produce a frame with a length that is not an integer number of octets. Complete frames that do not contain an integer number of octets should be truncated to the nearest octet boundary. If the FCS field is in error in such a frame, then alignmentError is reported; otherwise the frame should be accepted.

If the device under test (DUT) implements the Media Independent Interface (MII) and is operating at 10Mb/s it will translate the PLS\_DATA.indicate primitive to RXD<3:0>. If the DUT implements the MII and is operating at 100Mb/s, it will translate the rx\_code-bit to RXD<3:0>. In both these cases the MAC will receive data in nibbles (4 bits) and, therefore, the MAC layer can only receive a nibble of excess data.

If the DUT does not implement the MII the MAC layer receives the PLS\_DATA.indicate directly from the Physical Layer Signaling (PLS). In this case the MAC layer can have 1 to 7 bits of excess data.

**Test Setup:** Connect the device under test (DUT) to the testing station with the appropriate medium (i.e. unshielded twisted pair (UTP), shielded twisted pair (STP), balanced copper, multi-mode fiber, etc.) and transmit a valid frame to the DUT to ensure that the DUT is functioning properly. See Annex C for suggested test configurations.

**Procedure:**

*Part A:*

1. The testing station is used to source a frame to the DUT ending with a valid FCS and ‘n’ extra bits.
2. Repeat step 1 incrementing ‘n’ by ‘x’ according to Table 4 - 8.

*The University of New Hampshire  
InterOperability Laboratory*

*Part B:*

1. The testing station is used to source a frame to the DUT ending with an invalid FCS and ‘*n*’ extra bits.
2. Repeat step 1 incrementing ‘*n*’ by ‘*x*’ according to Table 4 - 8.

**Table 4 - 8 Value of ‘*x*’ for test 4.2.5**

<b>PHY SPEED</b>	<b>Initial Value of ‘<i>n</i>’</b>	<b>Increment ‘<i>n</i>’ by ‘<i>x</i>’ bits:</b>	<b>Repeat steps 1 through 2 until ‘<i>n</i>’ equals:</b>
PLS to MAC	1	$x = 1$	7
MII to MAC	4	<i>N/A</i>	4

*Part C:*

1. *Parts A* and *B* are repeated with the test frames preceded and followed by a valid frame, separated by minimum interFrameGaps (96 bit-times).

**Observable Results:**

- a. The DUT should truncate the test frame to the nearest octet and accept it.
- b. The DUT should truncate the test frame to the nearest octet, discard it and report an alignmentError.
- c. The reception of test frames should not affect the reception of the valid request frames.

**Possible Problems:**

- If it cannot be determined whether the DUT implements a PLS or an MII below the MAC layer then the testing is performed as if a PLS is implemented.

## Test #4.1.9 - Preamble Error Reception and Recovery

**Purpose:** To verify that the device under test (DUT) accepts frames which do not contain valid preamble.

### References:

- [1] IEEE Std 802.3, 2002 Edition - subclause 3.2.1, 4.2.6, 4.2.9, *procedure PhysicalSignalDecap*.
- [2] ANNEX A (informative) Table of Acronym Definitions
- [3] ANNEX B (informative) Testing Requirements
- [4] ANNEX C (informative) Suggested Test Setups and Configurations

### Resource Requirements:

- A testing station capable of transmitting arbitrary bit patterns in place of the last byte of preamble and capable of monitoring traffic from the DUT.

**Last Modification:** February 26, 2003

**Discussion:** The preamble, consisting of seven bytes of the following bit pattern 10101010, is appended to the beginning of a frame before it is passed down to the physical layer. Upon the reception of a frame the *PhysicalSignalDecap* procedure discards every bit of preamble until a valid Start of Frame Delimiter (SFD), the bit pattern 10101011, is seen. After the reception of the SFD, the *PhysicalSignalDecap* begins passing successive bits to RecieveLinkMgmt for passing to the LLC sublayer. The reception of invalid preamble should, therefore, not interfere with the reception of a valid MAC frame, as long as the invalid preamble is not identical to the SFD.

The preamble pattern, however, is used at 10Mb/s to stabilize and synchronize the physical medium; therefore, the reception of invalid preamble could cause a valid frame to be discarded. In addition, the 100BASE-X PCS replaces the first byte of preamble with a start of stream delimiter (/J/K/), the 1000BASE-X PCS replaces the first byte of preamble with a start of packet delimiter (/S/), and the 1000BASE-T PCS replaces the first two bytes of preamble with two start of stream delimiters. Upon the reception of a frame these are stripped off by the PCS and replaced with a byte of preamble.

**Test Setup:** Connect the device under test (DUT) to the testing station with the appropriate medium (i.e. unshielded twisted pair (UTP), shielded twisted pair (STP), balanced copper, multi-mode fiber, etc.) and transmit a valid frame to the DUT to ensure that the DUT is functioning properly. See Annex C for suggested test configurations.

### Procedure:

#### Part A:

1. The testing station is instructed to transmit a frame appended with the following bit pattern:

100/1000BASE-X

10101010 00000000 00000000 00000000 00000000 00000000 00000000 10101011



*The University of New Hampshire  
InterOperability Laboratory*

1000BASE-T

10101010 10101010 00000000 00000000 00000000 00000000 00000000 10101011

2. The output and statistics of the DUT are observed.

*Part B:*

1. The testing station is instructed to transmit a frame appended with the following bit pattern:

100/1000BASE-X

10101010 01111111 11111111 11111111 11111111 11111111 11111111 10101011

1000BASE-T

10101010 10101010 01111111 11111111 11111111 11111111 11111111 10101011

2. The output and statistics of the DUT are observed.

*Part C:*

1. The testing station is instructed to transmit a frame appended with the following bit pattern:

10101010 10101010 10101010 10101010 10101010 10101000 10101111 10101011

2. The output and statistics of the DUT are observed.

*Part D:*

1. *Parts A through C* are repeated with each test frame preceded and followed by a valid frame, each separated by a minimum interFrameGap.
2. The output and statistics of the DUT are observed.

**Observable Results:**

- a. The DUT should accept the Test Frame.
- b. The DUT should accept the Test Frame.
- c. The DUT should accept the Test Frame.
- d. The reception of the test frame should not interfere with the reception of valid frames.

**Possible Problems:** None

## **GROUP 2: Encapsulation and De-capsulation**

**Scope:** The following tests cover MAC operations specific to the encapsulation and de-capsulation of MAC frames.

**Overview:** These tests are designed to verify that the device under test properly receives and transmits properly formed MAC frames. The MAC functions explored are defined in Clause 4 of IEEE 802.3.

### **Test #4.2.1 - Transmit proper Preamble and SFD**

**Purpose:** To verify that the device under test (DUT) properly encapsulates a frame with eight bytes of combined preamble and start of frame delimiter (SFD).

#### **References:**

- [1] IEEE Std 802.3, 2002 Edition- subclause 3.2.1, 3.2.2, 4.2.5, 4.2.6, 4.2.8, 4.2.9, function TransmitLinkMgmt, procedures PhysicalSignalEncap and PhysicalSignalDecap
  - (a) 10Mb/s: 7.2.3.2, 14.2.1.1
  - (b) 100BASE-X: 22.2.3.2.1
  - (c) 1000BASE-T: 35.2.3.2.1, 40.3.1.3
  - (d) 1000BASE-X: 36.2.4.13, Figure 36-5 PCS Transmit ordered\_set state diagram
- [2] ANNEX A (informative) Table of Acronym Definitions
- [3] ANNEX B (informative) Testing Requirements
- [4] ANNEX C (informative) Suggested Test Setups and Configurations
- [5] ANNEX D Stressing the device under test (DUT)

#### **Resource Requirements:**

- A testing station capable of stressing the DUT and capable of capturing complete frames including the preamble and SFD. MDI, AUI, MII, GMII or PCS access and or control by the testing station are ideal.

**Last Modification:** July 14, 2004

**Discussion:** When the MAC is requested to send a new frame, it calls the procedure PhysicalSignalEncap. This procedure transmits 7 bytes of preamble and then 1 byte of SFD. The preamble pattern is used at 10Mb/s to stabilize and synchronize the physical medium. A 10Mb/s device is required to transmit 7 bytes of preamble, however, it is possible for the first two bits in a transmission to be lost while being transmitted from the DO circuit to the TD circuit in the Physical layer. Therefore, at a very minimum, a 10Mb/s device should source frames that have 54 bits of preamble.

For speeds greater than 10 Mb/s, the MAC is still required to transmit preamble and SFD but it is not necessary for stabilization and synchronization. The preamble bit pattern is:

10101010 10101010 10101010 10101010 10101010 10101010 10101010

/I/ is a twenty bit wide signal, for 1000BASE-X, consisting of two 10bit code\_groups, /K28.5/D5.6/ or /K28.5/D16.2/. The 1000BASE-X PCS may discard one octet of preamble if TX\_EN is set to TRUE while /K28.5/ is being transmitted because the PCS must transmit either /D5.6/ or /D16.2/ even if the first byte of preamble is being passed down from the MAC.

Upon the successful transmission of preamble, the MAC shall transmit the SFD, which consists of the pattern 10101011. Any successive bits following the transmission of SFD are recognized by the receiving MAC as data bits and are passed onto the LLC sublayer.

**Test Setup:** Connect the device under test (DUT) to the testing station with the appropriate medium (i.e. unshielded twisted pair (UTP), shielded twisted pair (STP), balanced copper, multi-mode fiber,

*The University of New Hampshire  
InterOperability Laboratory*

etc.) and transmit a valid frame to the DUT to ensure that the DUT is functioning properly. See Annex C for suggested test configurations.

**Procedure:**

*Part A:*

1. Stress the DUT according to ANNEX D.
2. The DUT is instructed to transmit a large number of valid frames, each separated by a minimum interFrameGap (IFG).
3. The activity captured by the testing station and the statistics gathered by the DUT are observed.

**Observable Results:**

- a. The testing station should capture several replies from the DUT. The preamble and SFD for each frame should conform to the appropriate bit pattern:

10Mb/s

10101010 10101010 10101010 10101010 10101010 10101010 10101010 10101011  
or  
0101010 10101010 10101010 10101010 10101010 10101010 10101010 10101011  
or  
101010 10101010 10101010 10101010 10101010 10101010 10101010 10101011

100BASE-X and 1000BASE-T

10101010 10101010 10101010 10101010 10101010 10101010 10101010 10101011

1000BASE-X

10101010 10101010 10101010 10101010 10101010 10101010 10101010 10101011  
or  
10101010 10101010 10101010 10101010 10101010 10101010 10101010 10101011

**Note:** The first octet of preamble is replaced with /J/K/ for 100BASE-X, or /S/ for 1000BASE-X, and the first two octets of preamble are replaced with SSD1 and SSD2 for 1000BASE-T by the PCS. The replaced octets should be received as preamble by the receiving MAC layer.

**Possible Problems:**

- In order to ensure that a device transmits proper preamble and SFD at all times it is necessary to stress the device. This may be difficult to do when the DUT is an end station.

*The University of New Hampshire  
InterOperability Laboratory*

**Test #4.2.2 - Transmission of minimum interFrameGap**

**Purpose:** To verify that the device under test (DUT) enforces minimum interframe spacing of 96 bit times.

**References:**

- [1] IEEE Std 802.3, 2002 Edition - subclauses 4.1.2.1.1, 4.2.8 function TransmitLinkMgmt, process deference and Figure 4.3 - Relationship among CSMA/CD procedures
- [2] ANNEX A (informative) Table of Acronym Definitions
- [3] ANNEX B (informative) Testing Requirements
- [4] ANNEX C (informative) Suggested Test Setups and Configurations
- [5] ANNEX D Stressing the device under test (DUT)

**Resource Requirements:**

- A testing station that is capable of stressing the DUT and capable of monitoring traffic from the DUT.

**Last Modification:** February 24, 2003

**Discussion:** In full duplex mode, the MAC is not required to defer to carrier sense, which is supplied to the MAC by the PHY. It is, however, necessary for the MAC to defer to its own transmission and continue to defer for at least one minimum interFrameGap (96 bit times) after the end of a frame.

**Test Setup:** Connect the device under test (DUT) to the testing station with the appropriate medium (i.e. unshielded twisted pair (UTP), shielded twisted pair (STP), balanced copper, multi-mode fiber, etc.) and transmit a valid frame to the DUT to ensure that the DUT is functioning properly. See Annex C for suggested test configurations.

**Procedure:**

*Part A:*

1. Stress the DUT according to ANNEX D.
2. The DUT is instructed to transmit a large number of valid frames, each separated by at least a minimum interFrameGap (IFG).

**Observable Results:**

- a. All frames captured should have at least a minimum IFG between them. Stressing the system should not cause the DUT to transmit frames separated by less than minimum interFrameGap.

**Possible Problems:** None.

### **Test #4.2.3 - Transmit proper length within the Length/Type field**

**Purpose:** To verify that the device under test (DUT) correctly calculates the length of the data field.

#### **References:**

- [1] IEEE Std 802.3, 2002 Edition - subclauses 3.2.6, 4.2.7.1, 4.2.8, *function* ComputePad (a) 1000Mb/s: 4.2.3.4
- [2] ANNEX A (informative) Table of Acronym Definitions
- [3] ANNEX B (informative) Testing Requirements
- [4] ANNEX C (informative) Suggested Test Setups and Configurations

#### **Resource Requirements:**

- A testing station that is capable of monitoring traffic from the DUT.

**Last Modification:** July 14, 2004

**Discussion:** There are several frame types including Ethernet II, 802.2 and 802.3. All Ethernet MAC frames have a Length/Type field of two bytes. The value of this field differs according to the type of frame. In Ethernet II, the Length/Type field is used exclusively to convey a type and does not indicate data length. In 802.2 and 802.3, values up to and including maxValidFrame (1500 octets) indicate the length of the MAC client data. Values greater than or equal to 1536 specify types rather than lengths and therefore should be accepted as valid frames. All other values are unspecified. In order to verify that the DUT is transmitting the length field correctly, it may be necessary to configure the device to transmit using Ethernet 802.3 framing. The length field is transmitted and received with the high order octet first.

If the size of the data field is less than the minimum required for proper operation of the protocol, a PAD field (a sequence of octets) will be added at the end of the data. The procedure that determines the size of the pad field is specified in clause 4.2.8. A device should compute the amount of pad add according to the ComputePad *function* and the *const* padSize. In half duplex mode at 1000Mb/s, extension should be added if the frame is not slotTime in length.

**Test Setup:** Connect the device under test (DUT) to the testing station with the appropriate medium (i.e. unshielded twisted pair (UTP), shielded twisted pair (STP), balanced copper, multi-mode fiber, etc.) and transmit a valid frame to the DUT to ensure that the DUT is functioning properly. See Annex C for suggested test configurations.

#### **Procedure:**

##### *Part A:*

1. If necessary, configure the device to transmit using Ethernet 802.3 framing.
2. Ideally, the DUT is instructed to transmit frames with 1 byte to 1500 bytes of data. Typically, the DUT is instructed to transmit 2 or 3 frames with varied amounts of data.

*The University of New Hampshire  
InterOperability Laboratory*

**Observable Results:**

- a. The testing station should capture each frame transmitted by the DUT. Each frame should have a length value in the length/type field equal to the amount of data in the data/pad field. In addition, frames less than minFrameSize should have pad equal to minFrameSize - (2 x addressSize + lengthOrTypeSize + clientDataSize + crcSize). Frames greater than minFrameSize shall not be padded.

**Possible Problems:**

- It might be difficult to force the DUT to transmit frames with a length value in the length/type field.
- The DUT may not support Ethernet 802.3 framing.

## **Test #4.2.4 - Compute and transmit proper CRC**

**Purpose:** To verify that the device under test (DUT) correctly calculates the CRC-32 value for the frame being transmitted and assigns it to the frame check sequence (FCS) field.

### **References:**

- [1] IEEE Std 802.3, 2002 Edition - subclause 3.2.8, 3.4 and 4.2.8
- [2] ANNEX A (informative) Table of Acronym Definitions
- [3] ANNEX B (informative) Testing Requirements
- [4] ANNEX C (informative) Suggested Test Setups and Configurations

### **Resource Requirements:**

- A testing station that is capable of capturing frames from the DUT and verifying that each captured frame has the proper CRC-32 value in the FCS field.

**Last Modification:** February 5, 2003

**Discussion:** In order to detect certain errors during the reception of a frame, a 32-bit Cyclic Redundancy Check (CRC) value is computed and added to the end of each packet. This value is inserted in the FCS field and it is computed using the contents of the source address, destination address, VLAN tag (optional), Length/Type, and Data/Pad fields (that is, all fields except the preamble, SFD, and FCS).

Upon the reception of a frame, the same calculation is performed on the incoming data and is compared to the value in the FCS field. If they do not match an error is reported to the MAC client.

**Test Setup:** Connect the device under test (DUT) to the testing station with the appropriate medium (i.e. unshielded twisted pair (UTP), shielded twisted pair (STP), balanced copper, multi-mode fiber, etc.) and transmit a valid frame to the DUT to ensure that the DUT is functioning properly. See Annex C for suggested test configurations.

### **Procedure:**

*Part A:*

1. The DUT is instructed to transmit several frames.
2. The CRC value of each frame is computed by the testing station and compared to the CRC transmitted by the DUT.

### **Observable Results:**

- a. The value of the CRC transmitted by the DUT must match the value calculated by the testing station.

**Possible Problems:** None



### **Test #4.2.5 - Receive variable preamble**

**Purpose:** To verify that the device under test (DUT) can receive valid frames with varied amounts of preamble.

#### **References:**

- [1] IEEE Std 802.3, 2002 Edition- subclauses 4.2.5, 4.2.9, process *BitReceiver* and procedure *PhysicalSignalDecap*
  - (a) 10BASE-T: 7.2.3.2, 14.2.1.1
  - (b) 100BASE-X: 24.2.2.1.4
  - (c) 1000BASE-X: 35.2.3.2.2, 36.2.4.13
  - (d) 1000BASE-T: 35.2.3.2.2, 40.3.1.4.1, Figure 40-10(a): PCS Receive State Diagram
- [2] ANNEX A (informative) Table of Acronym Definitions
- [3] ANNEX B (informative) Testing Requirements
- [4] ANNEX C (informative) Suggested Test Setups and Configurations

#### **Resource Requirements:**

- A testing station capable of transmitting frames with varied amounts of preamble and capable of monitoring traffic from the DUT.

**Last Modification:** July 14, 2004

**Discussion:** When the MAC is receiving a frame, the process *BitReceiver* first calls the procedure *PhysicalSignalDecap*. This procedure receives one bit at a time from the physical medium and discards all bits until a valid SFD is detected. At this point the *BitReceiver* process accepts bits while the *receiveDataValid* signal is asserted and the frame is not finished. Preamble is not used by the MAC layer so the minimum amount of preamble required for a device to function properly depends upon which physical layer is implemented and not upon the MAC layer.

At speeds less than 100 Mb/s, preamble is required for the synchronization of the receiver. The minimum amount of preamble that can be transmitted by a 10BASE-T device is 56 bits; two bits may be lost in the MAU between the DO circuit and the TD circuit. Therefore the 10BASE-T PHY should be able to handle a minimum of 54 bits of preamble.

At speeds greater than 10Mb/s preamble is not required for the synchronization of the receiver, however, the first octet of preamble is replaced with /J/K/ for 100BASE-X, or /S/ for 1000BASE-X, and the first two octets of preamble are replaced with SSD1 and SSD2 for 1000BASE-T by the PCS. The receiver's MAC layer should receive the replaced octets as preamble.

Though no more than 12 bytes of preamble will be observed within an actual network, a MAC layer should tolerate large amounts of preamble.

**Test Setup:** Connect the device under test (DUT) to the testing station with the appropriate medium (i.e. unshielded twisted pair (UTP), shielded twisted pair (STP), balanced copper, multi-mode fiber, etc.) and transmit a valid frame to the DUT to ensure that the DUT is functioning properly. See Annex C for suggested test configurations.

*The University of New Hampshire  
InterOperability Laboratory*

**Procedure:**

*Part A:*

1. The testing station is instructed to transmit a frame with the minimum amount of preamble followed by the SFD.
2. The testing station is then instructed to increment the amount of Preamble by 'n' and retransmit the frame.
3. Ideally, step 2 is repeated until a combined preamble and SFD of 64 bytes in length is obtained. Typically, a few different amounts of combined preamble and SFD are tested.

**Observable Results:**

- a. The DUT should accept the test frame with the minimum required preamble, as indicated in Table 4 - 9, and an SFD.

**Table 4 - 9 Acceptable Amounts of Preamble**

	<b>Minimum Preamble Required by the PHY</b>	<b>Value for 'n'</b>
<b>10Mb/s</b>	54 bits	1 bit
<b>100BASE-FX</b>	1 byte	4 bits
<b>100BASE-TX</b>		
<b>1000BASE-T</b>	2 bytes	1 byte
<b>1000BASE-X</b>	1 byte	1 byte

**Possible Problems:** None

## **Test #4.2.6 - Receive all Frame Sizes**

**Purpose:** To verify that the device under test (DUT) properly accepts all valid sized frames.

### **References:**

- [1] IEEE Std 802.3, 2002 Edition - subclauses 3.1.1, Figure 3-1 - MAC frame format, 3.5, Figure 3-3 - Tagged MAC frame format, 4.4.2
- [2] ANNEX A (informative) Table of Acronym Definitions
- [3] ANNEX B (informative) Testing Requirements
- [4] ANNEX C (informative) Suggested Test Setups and Configurations

### **Resource Requirements:**

- A testing station that is capable of transmitting valid untagged and tagged frames from minFrameSize to the maximum permitted frame size, and capable of monitoring traffic from the DUT.

**Last Modification:** July 19, 2004

**Discussion:** The MAC frame, as defined in clause 3.1.1, has a minFrameSize of 512 bits (64 bytes) and a maxUntaggedFrameSize of 1518 bytes. The MAC may support VLAN tagging, as defined in clause 3.5, which increases the maximum permitted size of a tagged frame to 1522 bytes (maxUntaggedFrameSize + qTagPrefixSize). The DUT should accept all frames from minFrameSize to maxUntaggedFrameSize. If the DUT supports VLAN tagging, then all untagged frames from minFrameSize to maxUntaggedFrameSize should be accepted and all tagged frames from minFrameSize to (maxUntaggedFrameSize + aTagPrefixSize) should be accepted.

**Test Setup:** Connect the device under test (DUT) to the testing station with the appropriate medium (i.e. unshielded twisted pair (UTP), shielded twisted pair (STP), balanced copper, multi-mode fiber, etc.) and transmit a valid frame to the DUT to ensure that the DUT is functioning properly. See Annex C for suggested test configurations.

### **Procedure:**

#### *Part A:*

1. The testing station is instructed to transmit a 64 byte untagged MAC frame. The output and statistics of the DUT are observed.
2. The test frame is then incremented by one octet and step 1 is repeated until the test frame is maxUntaggedFrameSize (1518 bytes) in length.

#### *Part B:*

1. If the DUT supports VLAN tagged frames and is properly configured, the testing station is instructed to transmit a 64 byte tagged MAC frame. The output and statistics of the DUT are observed.
2. The test frame is then incremented by one octet and step 1 is repeated until the test frame is maxUntaggedFrameSize + qTagPrefixSize (1522 bytes) in length.

*The University of New Hampshire  
InterOperability Laboratory*

**Observable results:**

- a. The DUT should accept all untagged frames 64 to 1518 bytes in length.
- b. If VLAN tagging is supported, the DUT should accept all tagged frames 64 to 1518 bytes in length. Tagged frames from 1519 to 1522 bytes in length may be accepted by the DUT (IEEE 802.3 Section 4.2.9 function ReceiveDataDecap recommends that these frames be accepted.).

**Possible Problems:**

- If the DUT does not support VLAN tagging than *Part B* cannot be tested.
- The DUT may not reply to frames with frames of equal size.
- The DUT may reply to VLAN tagged frames with untagged frames.
- At 1000Mb/s and in half duplex mode extension will have to be add to frames less than slotTime in length.

### **Test #4.2.7 - Reception of minimum interFrameGap**

**Purpose:** To determine whether or not the device under test (DUT) is capable of receiving frames separated by a minimum interFrameGap (IFG)

#### **References:**

- [1] IEEE Std 802.3, 2002 Edition - subclauses 4.2.3.2.1, 4.2.3.2.2, 4.4.2
  - (a) 10Mb/s: 7.2.1.1.2
  - (b) 100BASE-X: 22.2.3.1, Table 24-1
  - (c) 1000BASE-X: 36.2.4.14, Table 36-3
  - (d) 1000BASE-T: 40.3.1.3
- [2] ANNEX A (informative) Table of Acronym Definitions
- [3] ANNEX B (informative) Testing Requirements
- [4] ANNEX C (informative) Suggested Test Setups and Configurations

#### **Resource Requirements:**

- A testing station capable of transmitting frames with an interFrameGap of 96 bit times and capable of monitoring traffic from the DUT.

**Last Modification:** February 4, 2003

**Discussion:** The minimum interFrameGap is specified as 96 bit times regardless of the physical speed of the device. Regardless of the IFG used in transmission, the DUT must be capable of receiving frames separated by at least one IFG.

**Test Setup:** Connect the device under test (DUT) to the testing station with the appropriate medium (i.e. unshielded twisted pair (UTP), shielded twisted pair (STP), balanced copper, multi-mode fiber, etc.) and transmit a valid frame to the DUT to ensure that the DUT is functioning properly. See Annex C for suggested test configurations.

#### **Procedure:**

*Part A:*

1. The testing station is instructed to transmit two valid frames separated by a minimum IFG of 96 bit times.

#### **Observable Results:**

- a. The DUT must properly respond to the two frames that were separated by the minimum interFrameGap.

**Possible Problems:** None

### **Test #4.2.8 - Compute and transmit proper extension**

**Purpose:** To verify that the device under test (DUT) correctly calculates the amount of extension needed while transmitting a frame that is less than slotTime.

#### **References:**

- [1] IEEE Std 802.3, 2002 Edition - subclauses 3.2.9, 4.2.3.4 and 4.4.2.4
- [2] ANNEX A (informative) Table of Acronym Definitions
- [3] ANNEX B (informative) Testing Requirements
- [4] ANNEX C (informative) Suggested Test Setups and Configurations

#### **Resource Requirements:**

- A testing station capable of stressing the DUT and capable of capturing complete frames including carrier extension bits. GMII or PCS access and or control by the testing station are ideal.

**Last Modification:** February 24, 2003

**Discussion:** In half-duplex mode, at 1000Mb/s, the slotTime value employed at 100Mb/s or less is not sufficient to allow network topologies of adequate size. In order to maintain backwards compatibility the minimum frame size has not been modified. Rather extension bits are added to frames when necessary in order to achieve a slotTime of 4096 bit times (512 byte times). This ensures that all transmissions are at least slotTime in length. The extension field follows the FCS field, and is made up of a sequence of extension bits, which are readily distinguished from data bits. When transmitting extension the GMII signals should be TX\_EN de-asserted, TX\_ER asserted and TXD<7:0> = 0x0F. The necessary number of extension bits is determined by the process BitTransmitter and the procedure NextBit. The length of the field may be from zero to (slotTime – minFrameSize) or 448 bytes. The contents of the Extension field are not included in the FCS computation.

If the 1000Mb/s half duplex MAC receives a frame that is not slotTime in length, extended to slotTime, or part of a burst, then that frame is considered to be a fragment and should be discarded.

For 1000BASE-X, the End of Packet Delimiter (EPD) is considered to be part of IFG and extension. The PCS layer adds an EPD, which consists of /T/R/ or /T/R/R/ depending of the length of the frame, to the end of each frame. If the MAC layer indicates that there is extension to be transmitted, then the PCS continues to add /R/ code\_groups until the MAC layer indicates otherwise.

**Test Setup:** Connect the device under test (DUT) to the testing station with the appropriate medium (i.e. unshielded twisted pair (UTP), shielded twisted pair (STP), balanced copper, multi-mode fiber, etc.) and transmit a valid frame to the DUT to ensure that the DUT is functioning properly. See Annex C for suggested test configurations.

#### **Procedure:**

##### *Part A:*

1. The testing station is instructed to transmit a 64 byte frame and 448 bytes of extension. The output and statistics of the DUT are observed.

*The University of New Hampshire  
InterOperability Laboratory*

2. Ideally, the test frame is incremented by one octet, while the length of extension is decremented by one octet, and step 1 is repeated until the frame size is equal to slotTime (4096 bitTimes). Typically, a small number of frames are sent, these frames shall be less than slotTime in length but extended to slotTime.

**Observable Results:**

- a. The testing station should capture a reply to each test frame. This reply should consist of the test frame extend to slotTime (4096 bitTimes)

**Possible Problems:** None

### **Test #4.2.9 - Receive frames with extension**

**Purpose:** To verify that the device under test (DUT) can receive a frame with carrier extension while in full duplex mode at 1000Mb/s.

#### **References:**

- [1] IEEE Std 802.3, 2002 Edition – subclause 4.2.9, *function* ReceiveDataDecap, *process* BitReceiver
- [2] ANNEX A (informative) Table of Acronym Definitions
- [3] ANNEX B (informative) Testing Requirements
- [4] ANNEX C (informative) Suggested Test Setups and Configurations

#### **Resource Requirements:**

- A testing station that is capable of transmitting frames with carrier extension and capable of monitoring traffic from the DUT.

**Last Modification:** March 11, 2003

**Discussion:** In half duplex mode at 1000Mb/s, carrier extension is utilized to ensure adequate propagation time delay, without needing to increase minFrameSize. During the *ReceiveDataDecap* function a frame receives *receiveOK* status if no errors are contained within carrier extension (*extensionOK*). A device should, therefore accept any frame with extension, which has a carrier event that is at least slotTime in length.

In full duplex mode and at 1000Mb/s, carrier extension is not needed to ensure adequate propagation time delay; therefore, transmitted frames need only to meet minFrameSize in length. During the *ReceiveDataDecap* function, however, a frame receives *receiveOK* status if no errors are contained within carrier extension (*extensionOK*). A device should, therefore, accept a frame that has any amount of carrier extension.

In addition, the abundance of 1000BASE-X MAC/PCS combo chips and the lack of GMII interface chips caused many early 1000BASE-T devices to use the setup illustrated in Figure 4 - 4 (A similar setup is used by 1000BASE-T GBICs):

Given this implementation and the way the 1000BASE-X PCS functions, odd length frames transmitted by any device implanting the above configuration may have an extra byte of carrier extension appended to the end of the frame. This is because the end of packet delimiter (EPD) used by the 1000BASE-X PCS for odd sized frames, which consists of /T/R/R/. The /R/ code-group is also used by the 1000BASE-X PCS to denote carrier extension.

It has been demonstrated that some 1000BASE-T devices reject odd length frames with one byte of extension causing interoperability problems. While this set up may not be common, a 1000BASE-T device should be able to receive odd sized frames with one byte of carrier extension.



Figure 4 - 4 1000BASE-T PHY Utilizing a MAC/1000BASE-X PCS Combo Chip

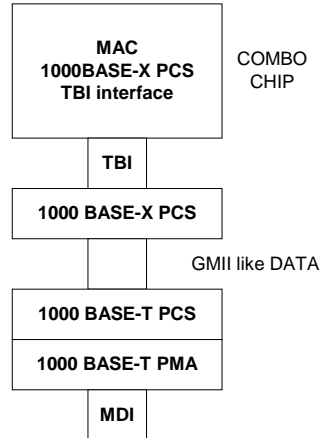

**Test Setup:** Connect the device under test (DUT) to the testing station with the appropriate medium (i.e. unshielded twisted pair (UTP), shielded twisted pair (STP), balanced copper, multi-mode fiber, etc.) and transmit a valid frame to the DUT to ensure that the DUT is functioning properly. See Annex C for suggested test configurations.

**Procedure:**

Full Duplex

*Part A:*

1. The testing station is instructed to transmit a valid 64 byte frame with one byte of extension.
2. The testing station is then instructed to retransmit the test frame after incrementing the length of extension by one. This step is repeated until [frame length + extension length] equals 1518 bytes.
3. The testing station is instructed to increment the length of the test frame by one byte and set the amount of extension to one byte.
4. Ideally, steps 2 and 3 would be repeated until the length of the test frame is 1517 bytes and the amount of extension is 1 byte. Typically, two or three test frames, varying from 64 to 1518 bytes in length, with varying amounts of extension are transmitted.

*Part B:*

1. *Parts A* through *C* are repeated with the test frame preceded and followed by a valid frame, separated by minimum interFrameGaps (96 bit-times).

Half Duplex

*Part A:*

1. The testing station is instructed to transmit a valid 512 byte frame with one byte of extension.
2. The testing station is then instructed to retransmit the test frame after incrementing the length of extension by one. This step is repeated until [frame length + extension length] equals 1518 bytes.

*The University of New Hampshire  
InterOperability Laboratory*

3. The testing station is instructed to increment the length of the test frame by one byte and set the amount of extension to one byte.
4. Ideally, steps 2 and 3 would be repeated until the length of the test frame is 1517 bytes and the amount of extension is 1 byte. Typically, two or three test frames, varying from 64 to 1518 bytes in length, with varying amounts of extension are transmitted.

*Part B:*

1. *Parts A through C* are repeated with the test frame preceded and followed by a valid frame, separated by minimum interFrameGaps (96 bit-times).

**Observable Results:**

- a. The DUT should accept each test frame.
- b. The reception of the test frame should not interfere with the reception of valid frames.

**Possible Problems:** None

### **GROUP 3: Full Duplex**

**Scope:** The following tests cover MAC operations specific to full duplex operation of the MAC.

**Overview:** These tests are designed to verify that the device under test properly implements the full duplex operation of the MAC. The MAC functions explored are defined in Clause 4 of IEEE 802.3.

### Test #4.3.1 - Does not defer

**Purpose:** To verify that the device under test (DUT) does not defer to carrier sense while in Full Duplex mode.

#### References:

- [1] IEEE Std 802.3, 2002 Edition - subclause 4.1.2.1.1, 4.2.4.2.1, 4.2.4.2.2, 4.2.8 *function* TransmitLinkMgmt, process deference and Figure 4.3 - Relationship among CSMA/CD procedures
- [2] ANNEX A (informative) Table of Acronym Definitions
- [3] ANNEX B (informative) Testing Requirements
- [4] ANNEX C (informative) Suggested Test Setups and Configurations

#### Resource Requirements:

- A testing station capable of generating traffic and capable of capturing frames with precise timestamps. MDI, AUI, MII, GMII or PCS access and or control by the testing station are ideal.

**Last Modification:** July 19, 2004

**Discussion:** Carrier sense is a physical signal provided to the MAC sublayer by the Physical layer, and it is asserted when any device on the network is transmitting. In half-duplex mode, the MAC must defer to carrier sense when there is a frame waiting to be sent. In full duplex mode, the MAC is required to have dedicated transmit and receive channels, this means that no collisions can occur. Therefore, deferring to carrier sense (traffic on the receive channel) is unnecessary. The MAC, however, must always defer to its own transmissions.

**Test Setup:** Connect the device under test (DUT) to the testing station with the appropriate medium (i.e. unshielded twisted pair (UTP), shielded twisted pair (STP), balanced copper, multi-mode fiber, etc.) and transmit a valid frame to the DUT to ensure that the DUT is functioning properly. See Annex C for suggested test configurations.

#### Procedure:

*Part A:*

1. The testing station is instructed to transmit a valid frame, a minimum IFG and then a long carrier event of sufficient length to determine whether or not deference has occurred.

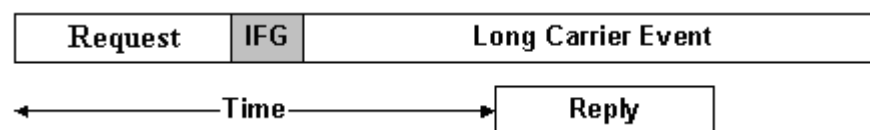

Figure 4 - 5 Does not defer

#### Observable Results:

*The University of New Hampshire  
InterOperability Laboratory*

- a. The testing station should receive a reply to the test frame. While in full duplex, the DUT should not defer to the long carrier event (the amount of time between when the testing station transmits the test frame and when it receives a reply to it should be less than then the long carrier event).

**Possible Problems:**

- Some devices may take a long time to generate a reply to the test frame.

### **Test #4.3.2 - No collisions**

**Purpose:** To verify that no collisions occur when the device under test (DUT) is in full duplex mode.

#### **References:**

- [2] IEEE Std 802.3, 2002 Edition - subclauses 4.1.2.1.1, 4.2.4.2.2, 4.3.3, function TransmitLinkMgmt and Figure 4.3 - Relationship among CSMA/CD procedures
- [3] ANNEX A (informative) Table of Acronym Definitions
- [4] ANNEX B (informative) Testing Requirements
- [5] ANNEX C (informative) Suggested Test Setups and Configurations

#### **Resource Requirements:**

- A testing station capable of transmitting a frame so that it is received while the DUT is transmitting and capable of monitoring traffic from the DUT.

**Last Modification:** July 19, 2004

**Discussion:** Carrier sense is a physical signal provided to the MAC sublayer by the Physical layer, and it is asserted when any device on the network is transmitting. In half-duplex mode, if carrier sense is asserted while a device is transmitted then a collision has occurred and the device must cease transmission of data and transmit a 32-bit jam pattern. In full duplex mode, the MAC is required to have dedicated transmit and receive channels, this means that no collisions can occur. Therefore, a device should not cause a collision when carrier sense is asserted while a frame is being transmitted.

**Test Setup:** Connect the device under test (DUT) to the testing station with the appropriate medium (i.e. unshielded twisted pair (UTP), shielded twisted pair (STP), balanced copper, multi-mode fiber, etc.) and transmit a valid frame to the DUT to ensure that the DUT is functioning properly. See Annex C for suggested test configurations.

#### **Procedure:**

*Part A:*

1. The DUT is instructed to transmit a valid frame.
2. The testing station is instructed to transmit a frame so that a collision would occur during data within slotTime if the device were in half duplex mode.
3. The output and statistics of the DUT are observed.

#### **Observable Results:**

- a. The testing station should receive the frame transmitted by the DUT. While in full duplex, no collisions or collision fragments should be observed.

**Possible Problems:** None

*The University of New Hampshire  
InterOperability Laboratory*

**Test #4.3.3 - No extension**

**Purpose:** To verify that the device under test (DUT) does not add extension to valid frames that are less than slotTime when in full duplex mode and at 1000Mb/s.

**References:**

- [1] IEEE Std 802.3, 2002 Edition - subclauses 4.2.7.5 *procedure* Initialize, and 4.2.8 *procedure* NextBit
- [2] ANNEX A (informative) Table of Acronym Definitions
- [3] ANNEX B (informative) Testing Requirements
- [4] ANNEX C (informative) Suggested Test Setups and Configurations

**Resource Requirements:**

- A testing station capable of stressing the DUT and capable of capturing complete frames including carrier extension bits. MDI, AUI, MII, GMII or PCS access and control by the testing station are ideal.

**Last Modification:** March 11, 2003

**Discussion:** At 1000Mb/s and in half duplex mode, the slotTime used for 10Mb/s and 100Mb/s is not large enough to propagate a collision to the extent required to support the desired network size. The length of slotTime was, therefore, lengthened from 512 bits to 4096 bits. In order to ensure that the minFrameSize did not have to be changed, carrier extension is appended to the end of the MAC frame. Carrier extension ensures that a receiver's PHY asserts carrier sense for slotTime (4096 bits) for frames that are less than slotTime in length.

In full-duplex mode at operating speeds at 1000Mb/s, carrier extension is not needed to ensure adequate propagation time delay; therefore, transmitted frames need only to meet minFrameSize in length.

**Test Setup:** Connect the device under test (DUT) to the testing station with the appropriate medium (i.e. unshielded twisted pair (UTP), shielded twisted pair (STP), balanced copper, multi-mode fiber, etc.) and transmit a valid frame to the DUT to ensure that the DUT is functioning properly. See Annex C for suggested test configurations.

**Procedure:**

*Part A:*

1. The testing station is instructed to transmit a valid 64 byte frame.
2. The testing station is instructed to retransmit the test frame, after incrementing its size by one.
3. Ideally, step 2 is repeated until the size of the test frame equals 511. Typically, a few sizes, varying from minFrameSize to one less than slotTime, are used.

**Observable Results:**

- a. All frames should be replied to/forwarded by the DUT without carrier extension

*The University of New Hampshire  
InterOperability Laboratory*

**Possible Problems:**

- For 1000BASE-X, one or two bytes of carrier extension, defined as /R/ by the clause 36 PCS, are added to the end of each frame as part of the End of Packet Delimiter (/T/R/ or /T/R/R/). If a 1000BASE-X device transmits more than one /R/ code-groups after the transmission of an odd sized frame or more than two /R/ code-groups after the transmission of an even sized frame, then the device shall be observed to transmit carrier extension.



### **Test #4.3.4 - No bursting**

**Purpose:** To verify that the device under test (DUT), at 1000Mb/s and in full duplex mode, does not go into burst mode when it has acquired the medium and there are still frames to send.

#### **References:**

- [1] IEEE Std 802.3, 2002 Edition - subclause 4.2.8 *function* TransmitLinkMgmt.
- [2] ANNEX A (informative) Table of Acronym Definitions
- [3] ANNEX B (informative) Testing Requirements
- [4] ANNEX C (informative) Suggested Test Setups and Configurations
- [5] ANNEX D Stressing the device under test (DUT)

#### **Resource Requirements:**

- A testing station capable of stressing the DUT and capable of capturing complete frames including carrier extension bits. MDI, AUI, MII, GMII or PCS access and or control by the testing station are ideal.

**Last Modification:** March 11, 2003

**Discussion:** In half duplex mode at 1000Mb/s, once a device has transmitted a frame, it may maintain control of the medium by transmitting carrier extension followed by another frame, followed by carrier extension, followed by another frame, etc. This is referred to as a burst.

In full-duplex mode at 1000Mb/s, once a frame has been successfully transmitted, a device can begin transmission of another frame without contending for the medium because the device need only defer to its own transmission. It is, therefore, not necessary for a device to maintain control of the medium by bursting.

**Test Setup:** Connect the device under test (DUT) to the testing station with the appropriate medium (i.e. unshielded twisted pair (UTP), shielded twisted pair (STP), balanced copper, multi-mode fiber, etc.) and transmit a valid frame to the DUT to ensure that the DUT is functioning properly. See Annex C for suggested test configurations.

#### **Procedure:**

*Part A:*

1. Stress the DUT according to ANNEX D.
2. The DUT is instructed to continuously transmit 1518 or 64 byte frames, each separated by a minimum interFrameGap. Some devices may be more likely to transmit 64 byte frames in burst mode.

#### **Observable Results:**

- a. The testing station should receive 5 replies separated by at least one minimum IFG. This IFG should not consist of carrier extension.

*The University of New Hampshire  
InterOperability Laboratory*

**Possible Problems:**

- It may be difficult to ensure that the DUT will not go into burst mode. Detecting a burst mode transmission can be verified by observing carrier extension during IFG. If the DUT is observed to only transmit idle between each test frame, we cannot ensure that the DUT will never go into burst mode. This could be due to timing issues, which were not conducive to burst mode.
- Some devices may not support frame bursting.

## **GROUP 4: Collision Behavior**

**Scope:** The following tests cover MAC operations specific to collision enforcement and detection.

**Overview:** These tests are designed to verify that the device under test properly implements the Carrier Sense Multiple Access with Collision Detection (CSMA/CD) algorithm as it pertains to the MAC function. The MAC functions explored are defined in Clause 4 of IEEE 802.3.

### **Test #4.4.1 - Collisions during preamble and SFD within slotTime.**

**Purpose:** To verify that the device under test (DUT) detects and enforces collisions that occur during the transmission of preamble and SFD within slotTime.

#### **References:**

- [1] IEEE Std 802.3, 2002 Edition - subclauses 4.1.2.2, 4.2.4.2.2, 4.2.3.2.3, 4.2.3.2.4, 4.2.3.2.5, 4.2.3.4, 4.2.8 *procedure* WatchForCollisions, 4.4.2, and Figure 4-4 (a): Transmit Frame State Diagram
  - (a) 10Mb/s: - 4.4.2.1
  - (b) 100BASE-X: - 4.4.2.3, 22.2.2.10, 24.2.4.2
  - (c) 1000BASE-X: - 4.4.2.4, 35.2.2.10 and Figure 35-13
  - (d) 1000BASE-T: - 4.4.2.4, 40.1.3.1, 40.3.1.3
- [2] ANNEX A (informative) Table of Acronym Definitions
- [3] ANNEX B (informative) Testing Requirements
- [4] ANNEX C (informative) Suggested Test Setups and Configurations

#### **Resource Requirements:**

- A testing station capable of transmitting a frame so that it is received while the DUT is transmitting and capable of monitoring traffic from the DUT.

**Last Modification:** March 14, 2003

**Discussion:** In half duplex mode the MAC sublayer monitors collisionDetect while it is transmitting a frame. The collisionDetect signal is generated only during transmission and is never true at any other time; in particular, it cannot be used during frame reception to detect collisions between two or more other stations. If a station is transmitting and the physical layer asserts collisionDetect signal, then a collision event has occurred.

A collision may occur during the generation of preamble or SFD. When this occurs, the station must complete transmission of preamble, transmit SFD and then transmit a 32-bit “jam” signal to enforce the collision. The content of “jam” is unspecified; it may be any fixed or variable pattern convenient to the media access implementation. The pattern shall not be intentionally designed to be the 32-bit CRC value corresponding to the (partial) frame transmitted prior to the jam. After a collision has occurred during the transmission of preamble or SFD the DUT should attempt to retransmit the frame.

**Test Setup:** Connect the device under test (DUT) to the testing station with the appropriate medium (i.e. unshielded twisted pair (UTP), shielded twisted pair (STP), balanced copper, multi-mode fiber, etc.) and transmit a valid frame to the DUT to ensure that the DUT is functioning properly. See Annex C for suggested test configurations.

#### **Procedure:**

*Part A:*

1. The DUT is instructed to transmit a valid frame.
2. The testing station is instructed to create a collision at the DUT ‘*n*’ bits (see Table 4 - 10 ) after the DUT begins transmission of preamble. The initial value of ‘*n*’ should be 0.

*The University of New Hampshire  
InterOperability Laboratory*

3. The activity captured by the testing station and the statistics gathered by the DUT are observed.
4. Ideally, steps 1 through 3 are repeated with the value of ‘*n*’ incremented by ‘*x*’ according to Table 4 - 10 . Typically, 2 or 3 values of ‘*n*’ are used to test functionality.

**Table 4 - 10 Values of “*n*” for test 4.1.1**

PHY SPEED	Increment “ <i>n</i> ” by “ <i>x</i> ” bits:	Repeat steps 1 through 3 until “ <i>n</i> ” equals:
≤ 10Mb/s	<i>x</i> = 1	64 bits
100Mb/s	<i>x</i> = 4	
1000Mb/s	<i>x</i> = 8	

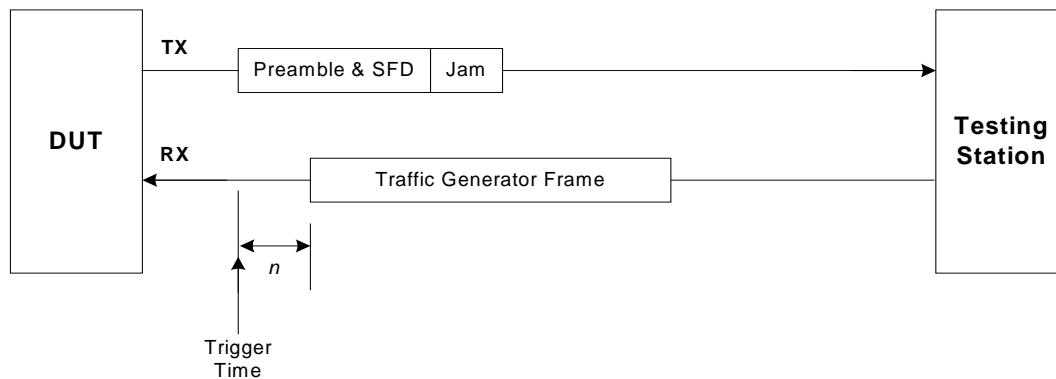

**Figure 4 - 6 Timing Diagram for Collisions during preamble or SFD**

*Part B:*

1. The testing station is instructed to monitor the medium for any retransmission attempts from the DUT.

**Observable results:**

- a. The testing station should capture a collision fragment. This fragment should consist of complete preamble, SFD and a 32-bit jam pattern.
- b. The testing station should capture a complete, valid reply indicating successful retransmission.

**Possible Problems:**

- It may not be possible to cause a collision during the transmission of preamble due to internal delays within the DUT.

### **Test #4.4.2 - Collisions after the reception of SFD within slotTime**

**Purpose:** To verify that the device under test (DUT) detects and enforces collisions that occur during the transmission of data within slotTime.

**References:**

- [1] IEEE Std 802.3, 2002 Edition - subclauses 4.1.2.2, 4.2.3.4, 4.2.3.2.3, 4.2.3.2.4 4.2.3.2.5, 4.2.4.2.2, 4.2.8 *procedure* WatchForCollisions, 4.4.2, and Figure 4-4 (a): Transmit Frame State Diagram
  - (a) 10Mb/s: - 4.4.2.1
  - (b) 100BASE-X: - 4.4.2.3, 22.2.2.10, 24.2.4.2
  - (c) 1000BASE-X: - 4.4.2.4, 35.2.2.10 and Figure 35-13
  - (d) 1000BASE-T: - 4.4.2.4, 40.1.3.1, 40.3.1.3
- [2] ANNEX A (informative) Table of Acronym Definitions
- [3] ANNEX B (informative) Testing Requirements
- [4] ANNEX C (informative) Suggested Test Setups and Configurations

**Resource Requirements:**

- A testing station capable of transmitting a frame so that it is received while the DUT is transmitting and capable of monitoring traffic from the DUT.

**Last Modification:** March 14, 2003

**Discussion:** In half duplex mode the MAC sublayer monitors collisionDetect while it is transmitting a frame. The collisionDetect signal is generated only during transmission and is never true at any other time; in particular, it cannot be used during frame reception to detect collisions between two or more other stations. If a station is transmitting and the physical layer asserts the collisionDetect signal, then a collision event has occurred.

When a collision occurs during transmission of data, before the completion of the slotTime timer, the station should cease transmission of data and transmit a 32-bit “jam” signal to enforce the collision. The slotTime timer begins with the transmission of the first bit of preamble. The content of the jam is unspecified; it may be any fixed or variable pattern convenient to the media access implementation. The pattern shall not be intentionally designed to be the 32-bit CRC value corresponding to the (partial) frame transmitted prior to the jam. After a collision has occurred during the transmission of data, within slotTime, the DUT should attempt to retransmit the frame.

**Test Setup:** Connect the device under test (DUT) to the testing station with the appropriate medium (i.e. unshielded twisted pair (UTP), shielded twisted pair (STP), balanced copper, multi-mode fiber, etc.) and transmit a valid frame to the DUT to ensure that the DUT is functioning properly. See Annex C for suggested test configurations.

**Procedure:**

*Part A:*

1. The DUT is instructed to transmit a valid frame.
2. The testing station is instructed to create a collision 'n' bits after the DUT transmits the first byte of preamble. The initial value of 'n' should cause a collision in the first byte of frame data after the SFD.
3. The activity captured by the testing station and the statistics gathered by the DUT are observed.
4. Ideally, steps 1 through 3 are repeated with the value of 'n' incremented by 'x' until 'n' = slotTime as shown in Table 4 - 11. Typically, 2 or 3 values of 'n' are used to test functionality.

**Table 4 - 11 Values of 'n' for test 4.1.2**

PHY SPEED	Increment 'n' by 'x' bits:	Repeat steps 1 through 3 until 'n' equals:
≤ 10Mb/s	x = 1	slotTime = 512 bits
100Mb/s	x = 4	
1000Mb/s	x = 8	slotTime = 512 bytes

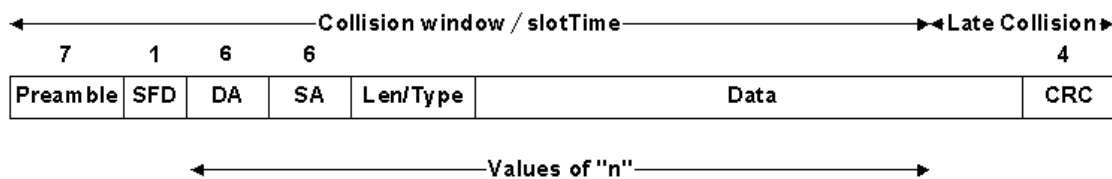

**Figure 4 - 7 Collisions after the reception of SFD within slotTime**

*Part B:*

1. The testing station is instructed to monitor the medium for any retransmission attempts from the DUT.

**Observable results:**

- a. When the value of 'n' is less than slotTime, the testing station should capture a collision fragment. This fragment should consist of complete preamble, SFD, any terminated data transmission and a 32-bit jam pattern. The jam pattern should not intentionally equal the CRC-32 value for the collision fragment.
- b. The testing station should capture a complete, valid reply indicating successful retransmission.

**Possible Problems:**

- If the jam pattern generated is not a fixed and readily identifiable pattern, it may be difficult to determine how many bits of jam were transmitted.

### **Test #4.4.3 - Collisions in data outside of slotTime while not bursting**

**Purpose:** To verify that the device under test (DUT) detects and enforces collisions that occur outside of slotTime while not in burst mode or within the first frame in a burst.

**References:**

- [1] IEEE Std 802.3, 2002 Edition - subclauses 4.1.2.2, 4.2.3.2.3, 4.2.3.2.4, 4.2.3.2.5, 4.2.3.2.7, 4.2.3.4, 4.2.4.2.2, 4.2.8, *procedure* WatchForCollisions, 4.2.9, 4.4.2.4, Figure 4-3: Relationship among CSMA/CD procedures and Figure 4-4 (a): Transmit Frame State Diagram
- [2] ANNEX A (informative) Table of Acronym Definitions
- [3] ANNEX B (informative) Testing Requirements
- [4] ANNEX C (informative) Suggested Test Setups and Configurations

**Resource Requirements:**

- A testing station capable of transmitting a frame so that it is received while the DUT is transmitting and capable of monitoring traffic from the DUT.

**Last Modification:** July 14, 2004

**Discussion:** In half duplex mode the MAC sublayer monitors collisionDetect while it is transmitting a frame. The collisionDetect signal is generated only during transmission and is never true at any other time; in particular, it cannot be used during frame reception to detect collisions between two or more other stations. If a station is transmitting and the physical layer asserts the collisionDetect signal, then a collision event has occurred.

If a collision occurs after slotTime has expired, then the collision is considered to be a late collision. The slotTime timer begins with the transmission of the first bit of preamble. When a late collision occurs the station should cease transmission of data and transmit a 32-bit “jam” signal to enforce the collision. The content of the jam is unspecified; it may be any fixed or variable pattern convenient to the media access implementation. The pattern shall not be intentionally designed to be the 32-bit CRC value corresponding to the (partial) frame transmitted prior to the jam.

At speeds less than 1000 Mb/s, slot time is 64 bytes (512 bits), and any collision that occurs after slotTime expires may be retransmitted.

At 1000 Mb/s, slot time is 512 bytes (4096 bits), and any collision that occurs after slotTime expires shall not be retransmitted.

**Test Setup:** Connect the device under test (DUT) to the testing station with the appropriate medium (i.e. unshielded twisted pair (UTP), shielded twisted pair (STP), balanced copper, multi-mode fiber, etc.) and transmit a valid frame to the DUT to ensure that the DUT is functioning properly. See Annex C for suggested test configurations.



**Procedure:**

*Part A:*

1. The DUT is instructed to transmit a valid 1518 byte frame.
2. The testing station is then instructed to create a collision 'n' bits into the frame (this includes preamble and SFD). The initial value of 'n' is indicated in Table 4 - 12. The output and statistics of the DUT are observed.
3. Ideally, steps 1 and 2 are repeated with the value of 'n' incremented by 'x' from [slotTime + 'x'] to 1518. Typically, 2 or 3 values of 'n' are used to test functionality.

**Table 4 - 12 Initial value for "n" for test 4.4.3**

PHY SPEED	slotTime	Initial value of 'n'	Value of 'x'
≤ 10Mb/s	512 bits (64 bytes)	513 bits	1 bit
100Mb/s		516 bits	4 bits
1000Mb/s	4096 bits (512 bytes)	513 bytes	1 byte

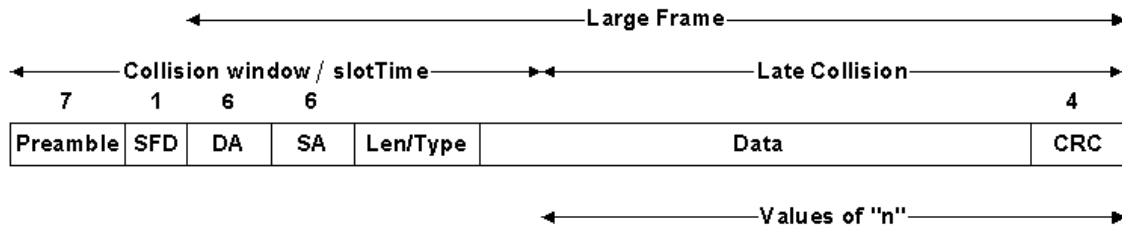

**Figure 4 - 8 Collisions in data after slotTime**

*Part B:*

1. The testing station is instructed to monitor the medium for any retransmission attempts from the DUT.

**Observable results:**

- a. The testing station should capture a collision fragment. This fragment should consist of complete preamble, SFD, any terminated data transmission and a 32-bit jam pattern. The jam pattern should not intentionally equal the CRC-32 value for the collision fragment.
- b. Any frames that are involved in a late collision should be detected by the DUT and may be retransmitted for speeds less than 1000 Mb/s, but not retransmitted for speeds equal to 1000 Mb/s.

**Possible Problems:**

- If the jam pattern generated is not a fixed and readily identifiable pattern, it may be difficult to determine how many bits of jam were transmitted.
- Some devices may not be able to transmit 1518 byte frames; another frame size will have to be used in order to determine how the DUT handles late collisions.

### **Test #4.4.4 - Collisions during extension within slotTime**

**Purpose:** To verify that the device under test (DUT) detects and enforces collisions that occur during carrier extension within slotTime.

#### **References:**

- [1] IEEE Std 802.3, 2002 Edition- subclauses 4.1.2.2, 4.2.3.2.3, 4.2.3.2.4, 4.2.3.2.5, 4.2.3.4, 4.2.4.2.2, 4.2.8 *procedure* WatchForCollisions, Figure 4-4 (a): Transmit Frame State Diagram, Figure 35.2.2.11 and Figure 35-14
  - (a) 1000BASE-X: - 4.4.2.4, 35.2.2.10 and Figure 35-13
  - (b) 1000BASE-T: - 4.4.2.4, 40.1.3.1, and 40.3.1.3
- [2] ANNEX A (informative) Table of Acronym Definitions
- [3] ANNEX B (informative) Testing Requirements
- [4] ANNEX C (informative) Suggested Test Setups and Configurations

#### **Resource Requirements:**

- A testing station capable of transmitting a frame so that it is received while the DUT is transmitting and capable of monitoring traffic from the DUT.

**Last Modification:** March 18, 2003

**Discussion:** In half duplex mode the MAC sublayer monitors collisionDetect while it is transmitting a frame. The collisionDetect signal is generated only during transmission and is never true at any other time; in particular, it cannot be used during frame reception to detect collisions between two or more other stations. If a station is transmitting and the physical layer asserts the collisionDetect signal, then a collision event has occurred.

In half-duplex mode at 1000 Mb/s, the slotTime employed at slower speeds is inadequate to accommodate network topologies of the desired physical extent. Carrier extension provides a means by which the slotTime can be increased to a sufficient value for the desired topologies, without increasing the minFrameSize parameter. Non-data bits, referred to as extension bits, are appended to frames which are less than slotTime bits in length so that the resulting transmission is at least one slotTime in duration. The maximum length of the extension is equal to the quantity, (slotTime – minFrameSize).

The MAC continues to monitor the medium for collisions during the transmission extension bits. When a collision occurs during the transmission of extension within slotTime, the station should cease transmission of extension and transmit a 32-bit jam signal to enforce the collision. The slotTime timer begins with the transmission of the first bit of preamble. The content of the jam must be extensionErrorBits. After a collision has occurred during the transmission of extension bits, within data, the DUT should attempt to retransmit the frames

**Test Setup:** Connect the device under test (DUT) to the testing station with the appropriate medium (i.e. unshielded twisted pair (UTP), shielded twisted pair (STP), balanced copper, multi-mode fiber, etc.) and transmit a valid frame to the DUT to ensure that the DUT is functioning properly. See Annex C for suggested test configurations.

*The University of New Hampshire  
InterOperability Laboratory*

**Procedure:**

*Part A:*

1. The DUT is instructed to transmit a valid 64 byte frame with 448 bytes of extension.
2. The testing station is instructed to create a collision 'n' octets after the DUT transmits the first byte of preamble. The initial value of 'n' should be 73. This should cause a collision to occur when the DUT is transmitting carrier extension.
3. The statistics and output of the DUT are observed.
4. Ideally, steps 1 through 3 are repeated with the value of 'n' incremented from 73 to slotTime (512 bytes). Typically, 2 or 3 values of 'n' are used to test functionality.

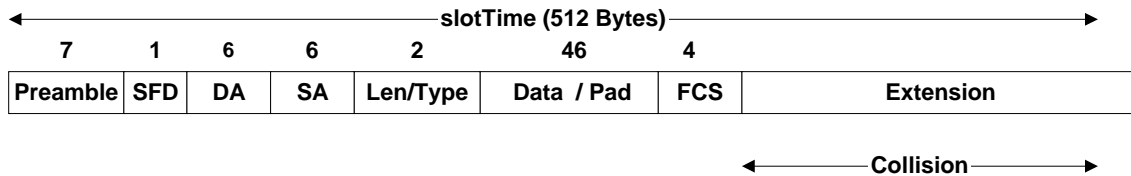

**Figure 4 - 9 Collisions during extension within slotTime**

*Part B:*

1. The testing station is instructed to capture any retransmission attempts from the DUT.

**Observable results:**

- a. The testing station should capture a collision fragment. This fragment should consist of complete preamble, SFD, complete data, any transmitted extension bits and a 32-bit jam pattern consisting of extension error bits.
- b. The testing station should capture a complete, valid reply indicating a successful retransmission.

**Possible Problems:** None

#### **Test #4.4.5 - Collisions during preamble and SFD outside of slotTime (Burst Mode).**

**Purpose:** To verify that the device under test (DUT) detects and enforces collisions that occur during the transmission of preamble and SFD outside of slotTime (in burst mode).

#### **References:**

- [1] IEEE Std 802.3, 2002 Edition- subclauses 4.1.2.2, 4.2.3.2.3, 4.2.3.2.4, 4.2.3.2.5, 4.2.3.2.7, 4.2.3.4, 4.2.4.2.2, 4.2.8 *procedure* WatchForCollisions, 4.2.9, 4.4.2.4, Figure 4.3: Relationship among CSMA/CD procedures and Figure 4-4 (a): Transmit Frame State Diagram
  - (a) 1000BASE-X: - 35.2.2.10 and Figure 35-13
  - (b) 1000BASE-T: - 40.1.3.1, and 40.3.1.3
- [2] ANNEX A (informative) Table of Acronym Definitions
- [3] ANNEX B (informative) Testing Requirements
- [4] ANNEX C (informative) Suggested Test Setups and Configurations

#### **Resource Requirements:**

- A testing station capable of transmitting a frame so that it is received while the DUT is transmitting and capable of monitoring traffic from the DUT.

**Last Modification:** April 8, 2003

**Discussion:** In half-duplex mode at 1000 Mb/s, an implementation may optionally transmit a series of frames without relinquishing control of the transmission medium. This mode of operation is referred to as burst mode. The first frame of a burst must always be at least slotTime in length (4096 bits), which may be accomplished through the addition of extension bits. Once this first frame has been successfully transmitted, the transmitting station can begin transmission of another frame without contending for the medium. Other stations on the network will continue to defer to its transmission, provided that the transmitting station does not allow the medium to assume an idle condition between frames. To do this the transmitting station fills the interFrame spacing interval with extension bits in order to maintain control of the medium. The transmitting station is allowed to initiate frame transmission until a specified limit, referred to as burstLimit, is reached. The value of burstLimit is specified in clause 4.4.2.4.

In a properly configured network, and in the absence of errors, collisions cannot occur during a burst at any time after the first frame of a burst has been transmitted. Therefore, the MAC will treat all collisions that occur after the first frame of a burst as a late collision. Within a burst of frames, the first frame of a burst must be at least slotTime bits in length in order to be accepted by the receiver, while subsequent frames within a burst must be at least minFrameSize in length. Anything less is presumed to be a fragment resulting from a collision, and is discarded by the receiver. The discarding of such a fragment by a MAC is not reported as an error.

The MAC continues to monitor the medium for collisions for the duration of the burst. If a collision occurs during the transmission of preamble or SFD outside of slotTime, the station should finish transmission of preamble and SFD and transmit a 32-bit jam signal to enforce the collision. The slotTime timer begins with the transmission of the first bit of preamble. The content of the jam is unspecified; it may be any fixed or variable pattern convenient to the media

*The University of New Hampshire  
InterOperability Laboratory*

access implementation. The pattern shall not be intentionally designed to be the 32-bit CRC value corresponding to the (partial) frame transmitted prior to the jam. Any collision that occurs during any frame, other than the first, within a burst is a late collision and should, therefore, not be retransmitted.

**Test Setup:** Connect the device under test (DUT) to the testing station with the appropriate medium (i.e. unshielded twisted pair (UTP), shielded twisted pair (STP), balanced copper, multi-mode fiber, etc.) and transmit a valid frame to the DUT to ensure that the DUT is functioning properly. See Annex C for suggested test configurations.

**Procedure:**

*Part A:*

1. The DUT is instructed to transmit a burst consisting of ten valid 64 byte frames. Ideally, each frame should have a sequence number to facilitate the observation phase. The first frame will be extended to slotTime (4096 bits). Each frame within the burst should be separated by 12 bytes of IFG consisting of carrier extension. This will yield a carrier event of 1288 bytes ( $532 + [9 * 84]$ ).
2. The testing station is instructed to create a collision ( $532 + n + [m * 84]$ ) octets after the DUT transmits the SPD. Initially 'n' and 'm' are set to zero. This will cause a collision to occur during the preamble of the second frame. The position is indicated by the arrow "A".
3. The statistics and output of the DUT are observed.
4. Ideally, steps 1 through 3 are repeated with the value of 'n' incremented from 0 to 7. When n is set to 8, the collision will occur during the transmission of SFD, which is indicated by the arrow "B". Typically, 1 or 2 values of 'n' are used to test functionality.
5. Ideally, steps 1 through 4 are repeated with the value of 'I' incremented for 0 to 8. This will test collisions in preamble and SFD in all the frames transmitted during the Burst. Arrows "Y" and "Z" indicate the final testing positions. Typically, 2 or 3 values of 'm' are used to test functionality.

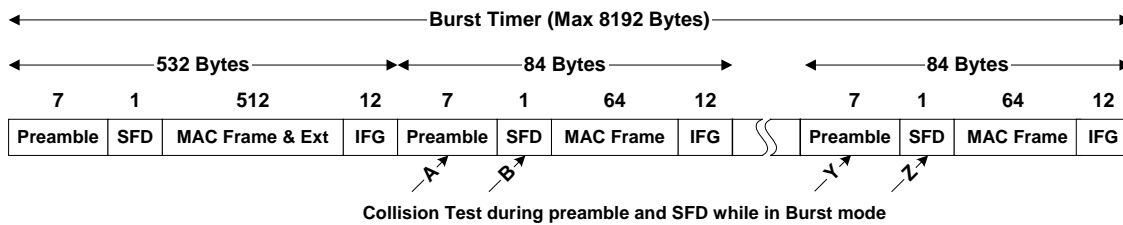

**Figure 4 - 10 Collisions during preamble and SFD outside of slotTime (Burst Mode)**

*Part B:*

1. The testing station is instructed to capture any retransmission attempts from the DUT.

**Observable results:**

- a. The testing station should capture a complete valid frame for all complete frames transmitted during the burst, prior to the collision. The number of these additional valid frames should equal the value of 'm'. The sequence numbers of the frames should be checked to verify that the correct frames were received. The testing station should then capture a collision fragment that indicates a collision occurring during preamble or SFD. This fragment should consist of

*The University of New Hampshire  
InterOperability Laboratory*

complete preamble, SFD and a 32-bit jam pattern. The jam pattern should not intentionally equal the CRC-32 value for the collision fragment.

- b. After the collision, the DUT should cease transmitting in burst mode and the DUT should not retransmit the frame involved in the collisions. The testing station should receive a total of nine frames and one collision.

**Possible Problems:**

- If the jam pattern generated is not a fixed and readily identifiable pattern, it may be difficult to determine how many bits of jam were transmitted.
- Bursting is optional so some devices may not support it.
- It may be difficult to force the DUT to transmit in burst mode.

### **Test #4.4.6 - Collisions during data outside of slotTime (Burst Mode)**

**Purpose:** To verify that the device under test (DUT) detects and enforces collisions that occur during the transmission of data outside of slotTime and within a burst.

#### **References:**

- [1] IEEE Std 802.3, 2002 Edition- subclauses 4.1.2.2, 4.2.3.2.3, 4.2.3.2.4 and 4.2.3.2.5, 4.2.3.2.7, 4.2.3.4, 4.2.4.2.2, 4.2.8 *procedure* WatchForCollisions, 4.2.9, 4.4.2.4, Figure 4-3: Relationship among CSMA/CD procedures and Figure 4-4 (a): Transmit Frame State Diagram
  - (a) 1000BASE-X: - 35.2.2.10 and Figure 35-13
  - (b) 1000BASE-T: - 40.1.3.1, and 40.3.1.3
- [2] ANNEX A (informative) Table of Acronym Definitions
- [3] ANNEX B (informative) Testing Requirements
- [4] ANNEX C (informative) Suggested Test Setups and Configurations

#### **Resource Requirements:**

- A testing station capable of transmitting a frame so that it is received while the DUT is transmitting and capable of monitoring traffic from the DUT.

**Last Modification:** April 8, 2003

**Discussion:** In half-duplex mode at 1000 Mb/s, an implementation may optionally transmit a series of frames without relinquishing control of the transmission medium. This mode of operation is referred to as burst mode. The first frame of a burst must always be at least slotTime in length (4096 bits), which may be accomplished through the addition of extension bits. Once this first frame has been successfully transmitted, the transmitting station can begin transmission of another frame without contending for the medium. Other stations on the network will continue to defer to its transmission, provided that the transmitting station does not allow the medium to assume an idle condition between frames. To do this the transmitting station fills the interFrame spacing interval with extension bits in order to maintain control of the medium. The transmitting station is allowed to initiate frame transmission until a specified limit, referred to as burstLimit, is reached. The value of burstLimit is specified in clause 4.4.2.4.

In a properly configured network, and in the absence of errors, collisions cannot occur during a burst at any time after the first frame of a burst has been transmitted. Therefore, the MAC will treat all collisions that occur after the first frame of a burst as a late collision. Within a burst of frames, the first frame of a burst must be at least slotTime bits in length in order to be accepted by the receiver, while subsequent frames within a burst must be at least minFrameSize in length. Anything less is presumed to be a fragment resulting from a collision, and is discarded by the receiver. The discarding of such a fragment by a MAC is not reported as an error.

The MAC continues to monitor the medium for collisions for the duration of the burst. If a collision occurs during the transmission of data outside of slotTime, the station should cease transmission of data and transmit a 32-bit jam signal to enforce the collision. The slotTime timer begins with the transmission of the first bit of preamble. The content of the jam is unspecified; it may be any fixed or variable pattern convenient to the media access implementation. The

*The University of New Hampshire  
InterOperability Laboratory*

pattern shall not be intentionally designed to be the 32-bit CRC value corresponding to the (partial) frame transmitted prior to the jam. Any collision that occurs during any frame, other than the first, within a burst is a late collision and should, therefore, not be retransmitted.

**Test Setup:** Connect the device under test (DUT) to the testing station with the appropriate medium (i.e. unshielded twisted pair (UTP), shielded twisted pair (STP), balanced copper, multi-mode fiber, etc.) and transmit a valid frame to the DUT to ensure that the DUT is functioning properly. See Annex C for suggested test configurations.

**Procedure:**

*Part A:*

1. The DUT is instructed to transmit 10 valid 64 byte frames. Ideally, each frame should have a sequence number to facilitate the observation phase. The first frame will be extended to slotTime (4096 bits). Each frame within the burst should be separated by 12 byte of IFG consisting of carrier extension. This will yield a carrier event of 1288 bytes (532 + [9 \* 84]).
2. The testing station is instructed to create a collision (532 + n + [m \* 84]) octets after the DUT transmits the first byte of preamble. Initially 'n' is set to 8 and 'm' is set to zero. This will cause a collision to occur during the data portion of the second frame. The arrow "A" indicates the position.
3. The statistics and output of the DUT are observed.
4. Ideally, steps 1 through 3 are repeated with the value of 'n' incremented from 8 to 63. This should cause a collision to occurring during each byte of data within the frame. Typically, 1 or 2 values of 'n' are used to test functionality.
5. Finally steps 1 through 4 are repeated with the value of 'm' incremented from 0 to 8. This will test collisions in data portion in all the frames sent during the Burst. The arrow "Z" indicates the final testing position.

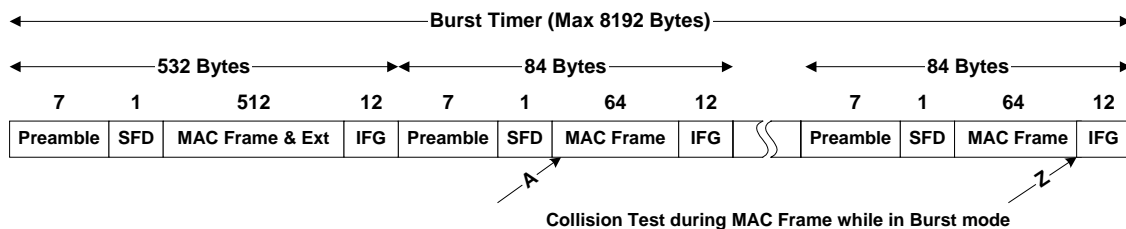

**Figure 4 - 11 Collisions during data outside of slotTime (Burst Mode)**

*Part B:*

1. The testing station is instructed to capture any retransmission attempts from the DUT.

**Observable results:**

- a. The testing station should capture a complete valid frame for all complete frames transmitted during the burst, prior to the collision. The number of these additional valid frames should equal the value of 'm'. The sequence numbers of the frames should be checked to verify that the correct frames were received. The testing station should then capture a collision fragment that indicates a collision occurring during the transmission of data. This fragment should consist of complete preamble, SFD, all data transmitted prior to the collision and a 32-bit jam pattern. The jam pattern should not intentionally equal the CRC-32 value for the collision fragment.



*The University of New Hampshire  
InterOperability Laboratory*

- b. After the collision, the DUT should cease transmitting in burst mode and the DUT should not retransmit the frame involved in the collisions. The testing station should receive a total of nine frames and one collision.

**Possible Problems:**

- If the jam pattern generated is not a fixed and readily identifiable pattern, it is difficult to determine how many bits of jam were transmitted.
- It may be difficult to force the DUT to transmit in burst mode.

### **Test #4.4.7 - Collisions during IFG within a Burst**

**Purpose:** To verify that the device under test (DUT) detects and enforces collisions that occur in the interFrame spacing between frames in a burst.

#### **References:**

- [1] IEEE Std 802.3, 2002 Edition - subclauses 4.1.2.2, 4.2.3.2.3, 4.2.3.2.4, 4.2.3.2.5, 4.2.3.2.7, 4.2.3.4, 4.2.4.2.2, 4.2.8 *procedure* WatchForCollisions, 4.2.9, 4.4.2.4, Figure 4.3: Relationship among CSMA/CD procedures and Figure 4-4 (a): Transmit Frame State Diagram
  - (a) 1000BASE-X: - 35.2.2.10 and Figure 35-13
  - (b) 1000BASE-T: - 40.1.3.1, and 40.3.1.3
- [2] ANNEX A (informative) Table of Acronym Definitions
- [3] ANNEX B (informative) Testing Requirements
- [4] ANNEX C (informative) Suggested Test Setups and Configurations

#### **Resource Requirements:**

- A testing station capable of transmitting a frame so that it is received while the DUT is transmitting and capable of monitoring traffic from the DUT.

**Last Modification:** March 18, 2003

**Discussion:** In half-duplex mode at 1000 Mb/s, an implementation may optionally transmit a series of frames without relinquishing control of the transmission medium. This mode of operation is referred to as burst mode. The first frame of a burst must always be at least slotTime in length (4096 bits), which may be accomplished through the addition of extension bits. Once this first frame has been successfully transmitted, the transmitting station can begin transmission of another frame without contending for the medium. Other stations on the network will continue to defer to its transmission, provided that the transmitting station does not allow the medium to assume an idle condition between frames. To do this the transmitting station fills the interFrame spacing interval with extension bits in order to maintain control of the medium. The transmitting station is allowed to initiate frame transmission until a specified limit, referred to as burstLimit, is reached. The value of burstLimit is specified in clause 4.4.2.4.

The MAC continues to monitor the medium for collisions for the duration of the burst. The receiving station accepts each complete frame in a burst individually. If a collision occurs in the IFG, within a burst, then the frame transmitted prior to it should be accepted and a 32-bit jam pattern, consisting of extension error bits, should be transmitted. If there was a frame waiting to be sent, its transmission should be deferred for at least minimum interFrame Spacing and follow normal deference rules. Also burst mode should be discontinued.

**Test Setup:** Connect the device under test (DUT) to the testing station with the appropriate medium (i.e. unshielded twisted pair (UTP), shielded twisted pair (STP), balanced copper, multi-mode fiber, etc.) and transmit a valid frame to the DUT to ensure that the DUT is functioning properly. See Annex C for suggested test configurations.

**Procedure:**

*Part A:*

1. The DUT is instructed to transmit 10 valid 64 byte frames. Ideally, each frame should have sequence numbers to facilitate in the observation phase. The first frame will be extended to slotTime (4096 bits). Each frame within the burst should be separated by 12 bytes of IFG consisting of carrier extension. This will yield a carrier event of 1288 bytes ( $532 + [9 * 84]$ ).
2. The testing station is instructed to create a collision at the DUT ( $532 + n + [m * 84]$ ) octets after the DUT transmits the first byte of preamble. Initially 'n' is set to 72 and 'm' is set to zero. This will cause a collision to occur during the interFrame spacing after the second frame in the burst. Arrow 'A' indicates the position.
3. The statistics and output of the DUT are observed.
4. Ideally, steps 1 through 3 are repeated with the value of 'n' incremented from 72 to 84. This should cause a collision during each byte of IFG. Typically, 1 or 2 values of 'n' are used to test functionality.
5. Finally steps 1 through 4 are repeated with the value of 'm' incremented from 0 to 8. This will test collisions in the IFG between each of the frames in the burst. Arrow 'Z' indicates the final testing position.

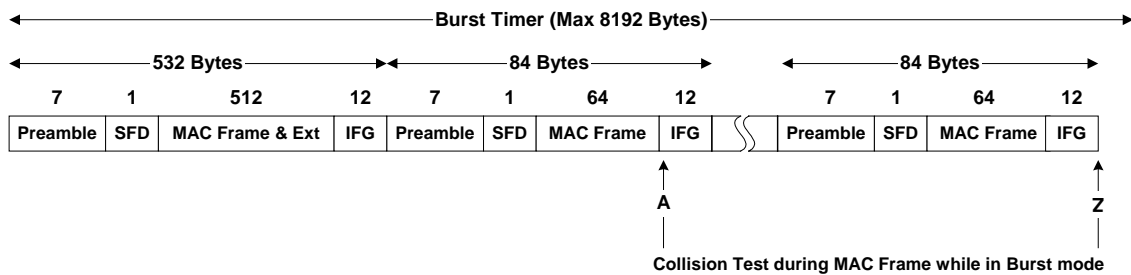

**Figure 4 - 12 Collisions during IFG outside of slot time (Burst Mode)**

**Observable results:**

- a. The testing station should receive each frame transmitted by the DUT. The DUT should discontinue transmitting in burst mode after each collision. The DUT may transmit the frames after the collision in a separate burst or individually.

**Possible Problems:**

- Some devices may not support bursting.
- It may be difficult to force the DUT to transmit in burst mode.

## **GROUP 5: Deference Process**

**Scope:** The following tests cover MAC operations specific to deference process.

**Overview:** These tests are designed to verify that the device under test properly defers to carrier sense. The MAC functions explored are defined in Clause 4 of IEEE 802.3.

### Test #4.5.1 - Defer to carrier sense while frame waiting

**Purpose:** To verify that the device under test (DUT) defers to the carrier sense signal when it has a frame waiting to be sent.

#### References:

- [1] IEEE Std 802.3, 2002 Edition - subclauses 4.1.2.1.1, 4.2.3.2.1, Figure 4-5 (b) and 4.2.8 process Deference, 5.2.4
- [2] ANNEX A (informative) Table of Acronym Definitions
- [3] ANNEX B (informative) Testing Requirements
- [4] ANNEX C (informative) Suggested Test Setups and Configurations

#### Resource Requirements:

- A testing station capable of generating traffic and capable of capturing frames with precise timestamps. MDI, AUI, MII, GMII or PCS access and or control by the testing station are ideal.

**Last Modification:** April 8, 2003

**Discussion:** The physical layer monitors the medium and when a carrier event is detected it provides carrier sense signaling to the MAC layer. In the event that carrier sense is indicated while a frame is in waiting, the DUT should delay the transmission of the frame until carrier sense is de-asserted.

If a device defers for interFrameSpacing (IFS) and carrier sense is not asserted (the medium is free of traffic) the MAC may transmit a frame waiting to be transmitted. A device must defer for at least one IFS in order to allow recovery time for other devices on the network.

**Test Setup:** Connect the device under test (DUT) to the testing station with the appropriate medium (i.e. unshielded twisted pair (UTP), shielded twisted pair (STP), balanced copper, multi-mode fiber, etc.) and transmit a valid frame to the DUT to ensure that the DUT is functioning properly. See Annex C for suggested test configurations.

#### Procedure:

##### Part A:

1. The testing station is instructed to transmit a valid frame, a minimum IFG and then a long carrier event of 'n' bytes. The initial value of 'n' should be of sufficient length to determine whether or not deference has occurred.
2. Step 1 is repeated and the value of 'n' is incremented by 'x'.
3. Steps 1 and 2 are repeated until 'n' is equal to jabber size in length and a consistent response pattern has been established.

**Table 4 - 13 Values for Test 4.5.1**

	Initial value for	Ideal Values for	Actual Values for	Minimum Jabber Size
--	-------------------	------------------	-------------------	---------------------

*The University of New Hampshire  
InterOperability Laboratory*

	'n'	'x'	'x'	
<b>10Mb/s</b>	'n' = 64 bytes	'x' = 1 bit	'x' = 100 bytes	75,000 bits
<b>100Mb/s</b>	'n' = 64 bytes	'x' = 4 bits		
<b>1000Mb/s</b>	'n' = 512 bytes	'x' = 8 bits	'x' = 1000 bytes	150,000 bits

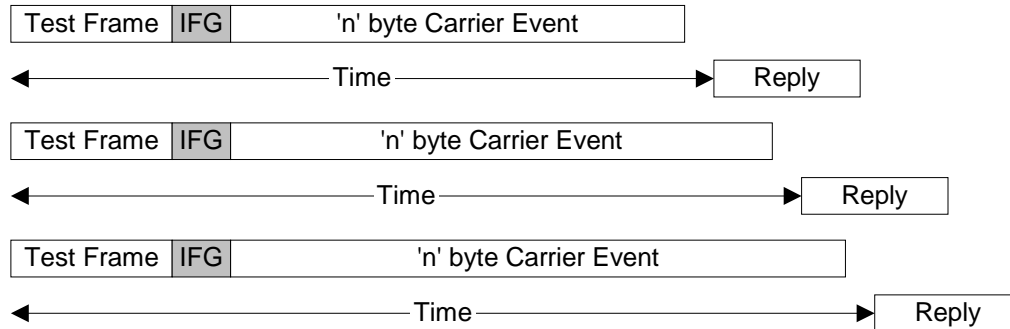

**Figure 4 - 13 Defer to carrier sense while frame waiting**

**Observable Results:**

- a. The time difference between the transmission of the last bit of the valid frame and the reception of the first bit of the reply from the DUT is measured and recorded as  $\Delta t$ . If  $\Delta t$  is greater than the length of the long carrier event plus the length of the test frame and minimum IFG then the DUT deferred to carrier sense. Each time the value of 'n' is incremented by 'x', there should be a consistent increase in  $\Delta t$ . This verifies that the delay is due to deferral and not to delays in the medium. The DUT may log the optional clause 30 error, "aFrameWithExcessiveDeferral", after it has deferred for 3036 bytes for 10Mb/s and 100Mb/s, or 19422 bytes for 1000Mb/s. Logging this error shall not affect MAC functionality.

**Possible Problems:**

- Some devices may require a long time to generate a reply to the test frame.
- **100BASE-TX:** Even though the maximum jabber frame is defined to be a 75000-bit frame, an issue may occur before this maximum number of bits can be transmitted to the DUT. The receive descrambler of the DUT may lose synchronization during the reception of a frame jabber size in length. Typically this can happen when more than 36100 bits are received without at least receiving 29 consecutive idle bits. Refer to the ANSI X3T9.5 TP-PMD standard in section 7.2.3.3 "Loss of Synchronization".

### **Test #4.5.2 - Deference after collision**

**Purpose:** To verify that the device under test (DUT) continues to observe the deference process when it attempts to retransmit after a collision, which occurred within slotTime.

#### **References:**

- [1] IEEE Std 802.3, 2002 Edition - subclauses 4.1.2.1.1, 4.2.3.2.1, 4.2.3.2.3, 4.2.3.2.4, 4.2.8, 4.4.2, *process* Deference and fig. 4.5(b)-Deference process
- [2] ANNEX A (informative) Table of Acronym Definitions
- [3] ANNEX B (informative) Testing Requirements
- [4] ANNEX C (informative) Suggested Test Setups and Configurations

#### **Resource Requirements:**

- A testing station capable of generating traffic and capable of capturing frames with precise timestamps. MDI, AUI, MII, GMII or PCS access and or control by the testing station are ideal.

**Last Modification:** April 29, 2003

**Discussion:** The physical layer monitors the medium and in the case of a collision it provides collision detect signal. In the event of a collision detect signal the DUT should cease transmitting and “BackOff” for a random amount of time before attempting to retransmit the frame involved in the collision. If the medium is idle after the DUT has backed off then it may attempt to retransmit the frame. If, however, carrier is detected on the media, the DUT must defer to the station that has control of the media, thus delaying the retransmission of the frame for the duration of the carrier event plus interFrameSpacing.

**Test Setup:** Connect the device under test (DUT) to the testing station with the appropriate medium (i.e. unshielded twisted pair (UTP), shielded twisted pair (STP), balanced copper, multi-mode fiber, etc.) and transmit a valid frame to the DUT to ensure that the DUT is functioning properly. See Annex C for suggested test configurations.

#### **Procedure:**

##### *Part A:*

1. The DUT is instructed to transmit a valid frame.
2. When the testing station detects the beginning of preamble on its receiver it is instructed to transmit a long carrier event of ‘*n*’ bytes (see Table 4 - 14).
3. The value ‘*n*’ should be incremented by ‘*x*’ (according to Table 4 - 14) and steps 1 and 2 should be repeated until a consistent pattern of increasing response times can be established.

**Table 4 - 14 Values of ‘n’ and ‘x’ for Test 4.5.2**

	Initial value for ‘n’	Ideal Values for ‘x’	Actual Values for ‘x’	Minimum Jabber Size
<b>10Mb/s</b>	‘n’ = 64 bytes	‘x’ = 1 bit	‘x’ = 100 bytes	75,000 bits
<b>100Mb/s</b>	‘n’ = 64 bytes	‘x’ = 4 bits		
<b>1000Mb/s</b>	‘n’ = 512 bytes	‘x’ = 8 bits	‘x’ = 1000 bytes	150,000 bits

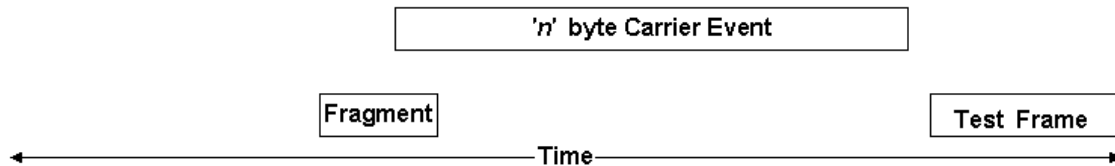

**Figure 4 - 14 Deference after collision**

**Observable Results:**

- a. The time difference between the transmission of the last bit of the valid frame and the reception of the first bit of the reply from the DUT is measured and recorded as  $\Delta t$ . The time difference ( $\Delta t$ ) between the reception of the collision fragment and the retransmission of the DUT reply can also be observed. Each time the value of ‘n’ is incremented by ‘x’, there should be a consistent increase in  $\Delta t$ . This verifies that the delay is due to deference and not to delays in the medium. The DUT may log the optional clause 30 error, “aFrameWithExcessiveDeferral”, after it has deferred for 3036 bytes for 10Mb/s and 100Mb/s, or 19422 bytes for 1000Mb/s. Logging this error shall not affect MAC functionality.

**Possible Problems:**

- Some devices may require a long time to generate a reply to the test frame.
- **100BASE-TX:** Even though the maximum jabber frame is defined to be a 75000-bit frame, an issue may occur before this maximum number of bits can be transmitted to the DUT. The receive descrambler of the DUT may lose synchronization during the reception of a frame jabber size in length. Typically this can happen when more than 36100 bits are received without at least receiving 29 consecutive idle bits. Refer to the ANSI X3T9.5 TP-PMD standard in section 7.2.3.3 “Loss of Synchronization”.



### **Test #4.5.3 - Interframe Spacing**

**Purpose:** To verify that the device under test (DUT) observes the 2/3 rule for interFrameSpacing.

#### **References:**

- [1] IEEE Std 802.3, 2002 Edition - subclauses 4.1.2.1.1, 4.2.3.2.1, 4.2.3.2.2, Figure 4-5 (b) and 4.2.8 *process* Deference
  - (a) 10Mb/s: 7.2.1.1.2
  - (b) 100BASE-X: 22.2.3.1, Table 24-1
  - (c) 1000BASE-X: 36.2.4.14, Table 36-3
  - (d) 1000BASE-T: 40.3.1.3, 7.2.1.1.2
- [2] ANNEX A (informative) Table of Acronym Definitions
- [3] ANNEX B (informative) Testing Requirements
- [4] ANNEX C (informative) Suggested Test Setups and Configurations
- [5] ANNEX D Stressing the device under test (DUT)

#### **Resource Requirements:**

- A testing station that is capable of transmitting so that a frame is received by the DUT during interFrame Spacing and capable of monitoring traffic from the DUT.

**Last Modification:** July 19, 2004

**Discussion:** In half duplex mode, carrier sense is a physical signal provided by the physical layer to the MAC when any device on the network is transmitting. InterFrameSpacing, which is equal to interFrameGap (96 bit times), begins when a device is not transmitting and carrier sense is false. The interFrameSpacing is divided into two parts: IFSP1, which is defined as 2/3 or less of interFrameSpacing, and interFrameSpacingPart2 (IFSP2), which is equal to [interFrameSpacing – IFSP1]. If carrier sense is asserted during IFSP1 then the DUT must defer the transmission of any frames in waiting until after carrier sense is de-asserted. If carrier sense is asserted during IFSP2 then the DUT must transmit a frame that is in waiting when IFS is completed.

The value for interFrameSpacingPart1 is not defined but is determined by the vendor. An initial period shorter than 2/3 of interFrameSpacing is permissible down to and including zero.

**Test Setup:** Connect the device under test (DUT) to the testing station with the appropriate medium (i.e. unshielded twisted pair (UTP), shielded twisted pair (STP), balanced copper, multi-mode fiber, etc.) and transmit a valid frame to the DUT to ensure that the DUT is functioning properly. See Annex C for suggested test configurations.

#### **Procedure:**

##### *Part A:*

1. Stress the DUT according to ANNEX D.
2. The testing station is instructed to send a valid frame, a minimum IFG, a long carrier event and finally another long carrier event that is separated by an IFG consisting of idle. The length of the IFG is 'n' (see Table 4 - 15).

*The University of New Hampshire  
InterOperability Laboratory*

3. The value of 'n' is incremented by 'x' and step one is repeated until a collision occurs (see Figure 4 - 15 and Figure 4 - 16).

**Table 4 - 15 Values for interFrameSpacing Test**

	Initial value of 'n'	Value of 'x'
<b>10Mb/s</b>	'n' = 1 bit	'x' = 1 bit
<b>100Mb/s</b>	'n' = 4 bits	'x' = 4 bits
<b>1000BASE-T</b>	'n' = 8 bits	'x' = 8 byte
<b>1000BASE-X</b>	'n' = 32 bits	

**Note:** For 1000BASE-X devices the smallest IFG is 4 bytes long (because /I/ is a two code-group sequence and because end of packet delimiter (EPD) is a two or three byte sequence). In order to increment the length of the IFG between the two long carrier events, it is necessary to send two different carrier events, one an odd number of octets and one an even number of octets, for each amount of /I/ transmitted.

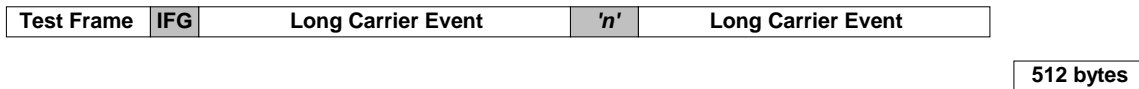

**Figure 4 - 15 Carrier Sense Asserted During IFSP1**

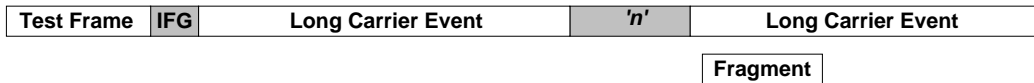

**Figure 4 - 16 Carrier Sense Asserted During IFSP2**

**Observable Results:**

- a. If the testing station receives a reply without collision after the long carrier events, it indicates that IFSP1 did not expire. This means that IFSP1 is greater than 'n'. If the testing station captures a collision fragment and then a reply after completing step 2, IFSP1 is less than or equal to the IFG 'n'. The value of IFSP1 must not be larger than 2/3 of interFrameSpacing (96 bit times).

**Possible Problems:** None

## **GROUP 6: Backoff**

**Scope:** The following tests cover MAC operations specific to collision backoff and retransmission (half duplex mode only) and the truncated binary exponential backoff (TBEBO) algorithm.

**Overview:** These tests are designed to verify that the device properly implements the TBEBO mechanism. The MAC functions explored are defined in Clause 4 of IEEE 802.3.

### **Test #4.6.1 - Retransmission attempt limit**

**Purpose:** To verify that the device under test (DUT) allows a maximum of 15 attempts for retransmission after a collision.

#### **References:**

- [1] IEEE Std 802.3, 2002 Edition - subclauses 4.1.2.2, 4.2.3.2.3, 4.2.3.2.4, 4.2.3.2.5, 4.4.2.4, 35.2.2.10, 36.2.5.2.1, Figure 4-4 (a): Transmit Frame State Diagram and Figure 35-13: Transmission with collision
- [2] ANNEX A (informative) Table of Acronym Definitions
- [3] ANNEX B (informative) Testing Requirements
- [4] ANNEX C (informative) Suggested Test Setups and Configurations

#### **Resource Requirements:**

- A testing station capable of transmitting a frame so that it is received while the DUT is transmitting and capable of monitoring traffic from the DUT.

**Last Modification:** July 19, 2004

**Discussion:** In half duplex mode, if a device is transmitting a frame and then receives a frame, a collision occurs. After a collision each station is required to transmit 32 bits of jam so that the collision is propagated to all stations on the network and to back off for a random amount of time before attempting to retransmit the frame involved in the collision.

In the event of repeated collisions during the attempted transmission of a frame, the DUT should only attempt a total of only 15 retransmissions, for a total of 16 transmission attempts, and then drop the frame and report an error.

**Test Setup:** Connect the device under test (DUT) to the testing station with the appropriate medium (i.e. unshielded twisted pair (UTP), shielded twisted pair (STP), balanced copper, multi-mode fiber, etc.) and transmit a valid frame to the DUT to ensure that the DUT is functioning properly. See Annex C for suggested test configurations.

#### **Procedure:**

##### *Part A:*

1. In half duplex mode the DUT is instructed to transmit a properly encapsulated, valid frame.
2. The testing station is then instructed to send a fragment so that a collision occurs within slotTime.
3. Step 2 is repeated until transmission attempts from the DUT cease, or until a consistent pattern of retransmission attempts can be determined.

#### **Observable results:**

- a. The testing station should capture 16 collision fragments. Each fragment should consist of complete preamble, any terminated data transmission and a 32-bit jam pattern. The testing station should not capture a complete, valid frame.

*The University of New Hampshire  
InterOperability Laboratory*

**Possible Problems:**

- Some devices will not cease attempting to retransmit frames involved in collisions. This may not indicate that there is a problem with the MAC sublayer, but that a higher layer is initiating the retransmission attempts.

## **Test #4.6.2 - Truncated Binary Exponential BackOff test**

**Purpose:** To verify that the device under test (DUT), correctly calculates the time to wait before attempting retransmission.

### **References:**

- [1] IEEE Std 802.3, 2002 Edition - subclauses 4.1.2.2, 4.2.3.2.3, 4.2.3.2.4, 4.2.3.2.5, 4.4.2, 35.2.2.10, 36.2.5.2.1, Figure 4-4 (a): Transmit Frame State Diagram and Figure 35-13: Transmission with collision
- [2] ANNEX A (informative) Table of Acronym Definitions
- [3] ANNEX B (informative) Testing Requirements
- [4] ANNEX C (informative) Suggested Test Setups and Configurations

### **Resource Requirements:**

- A testing station capable of transmitting a frame so that it is received while the DUT is transmitting and capable of monitoring the time delay before any retransmission attempts from the DUT.

**Last Modification:** July 19, 2004

**Discussion:** In half duplex mode, if a device is transmitting a frame and then receives a frame, a collision occurs. After a collision, each station is required to transmit 32 bits of jam so that the collision is propagated to all stations on the network and to back off for a random amount of time before attempting to retransmit the frame involved in the collision.

The scheduling of the retransmissions is determined by a controlled randomization process called **Truncated Binary Exponential BackOff**. At the end of enforcing a collision (jamming), the CSMA/CD sublayer delays before attempting to retransmit the frame. The delay is an integer multiple of slotTime. The number of slotTimes to delay before the n<sup>th</sup> retransmission attempt is chosen as a uniformly distributed random integer r in the range:

$$0 \leq r < 2^k \quad \text{where } k = \min(n, 10)$$

The value for 'k' should always be the lesser of the value of 'n' and the number 10. The value of 'k' is then used to determine the range for 'r'. Because 'r' is chosen as a uniformly distributed random integer in this range, we can use the value of 'r' to determine compliance of the DUT. Repeated samples are acquired for each value of 'k' to determine the distribution of 'r'.

**Test Setup:** Connect the device under test (DUT) to the testing station with the appropriate medium (i.e. unshielded twisted pair (UTP), shielded twisted pair (STP), balanced copper, multi-mode fiber, etc.) and transmit a valid frame to the DUT to ensure that the DUT is functioning properly. See Annex C for suggested test configurations.

*The University of New Hampshire  
InterOperability Laboratory*

**Procedure:**

*Part A:*

1. In half duplex mode, the DUT is instructed to transmit a valid frame.
2. The testing station is then instructed to send a fragment so that a collision occurs at the DUT within slotTime.
3. Step 2 is repeated 15 times and the time difference between retransmission attempts is recorded.
4. This test should be repeated until the testing station has acquired a sufficient number of samples to determine whether or not the average backoff for each of the fifteen different retransmission attempts is more aggressive than the expected average for that attempt, which is  $\frac{1}{2}(2^k-1)$ .

*Part B:*

1. In half duplex mode, the DUT is instructed to transmit a valid frame.
2. The testing station is then instructed to send a fragment so that a collision occurs at the DUT within slotTime.
3. Step 2 is repeated 15 times and the time difference between retransmission attempts is recorded.
4. This test should be repeated until the testing station has acquired a sufficient number of samples to determine the underlying distribution of the random variable 'r'.

**Observable results:**

- a. It is acceptable for the combined average backoff for any of the fifteen retransmission attempts to be less aggressive but it is unacceptable for any to be more aggressive.
- b. Each time the procedure is executed, the time difference between transmissions should be 0 to  $(2^k - 1)$ . Given enough samples, the distribution of the values for 'r' should be uniformly distributed random integer values.

**Possible Problems:**

- If a device has a very slow response time it may be difficult to collect enough measurements to accurately test the DUT's back off algorithm.

## **GROUP 7: Frame Bursting**

**Scope:** The following tests cover MAC operations specific to Gigabit devices running in half duplex mode and bursting.

**Overview:** These tests are designed to verify that the device under test (DUT) correctly implements Burst Mode as defined in the IEEE standard. This includes verifying that the DUT transmits extension in interframe Spacing interval when in burst mode and that it enforces the burst timer of 64Kb (65536). The MAC functions explored are defined in Clause 4 of IEEE 802.3.



### **Test #4.7.1 - Interframe Fill**

**Purpose:** To verify that the device under test (DUT), when in half duplex mode at 1000Mb/s, transmits extension in the interframe spacing interval when in burst mode.

#### **References:**

- [1] IEEE Std 802.3, 2002 Edition - subclauses 4.2.3.2.7, 4.2.3.4, 4.2.8, 4.2.9 and 4.4.2.4; procedure *InterFrameSignal*.
- [2] ANNEX A (informative) Table of Acronym Definitions
- [3] ANNEX B (informative) Testing Requirements
- [4] ANNEX C (informative) Suggested Test Setups and Configurations

#### **Resource Requirements:**

- A testing station capable of capturing complete frames including carrier extension bits transmitted by the DUT. GMII or PCS access and or control by the testing station are ideal.

**Last Modification:** April 8, 2003

**Discussion:** At speeds equal to 1000Mb/s, once a frame has been successfully transmitted (with extension if necessary), the transmitting station can begin transmission of another frame without contending for the medium because all of the other stations on the network will continue to defer to its transmission, provided that it does not allow the medium to assume an idle condition between frames. The transmitting station fills the interframe spacing interval with extension bits, which are readily distinguished from data bits at the receiving stations, and ensure the detection of carrier by the receiving stations. The length of this interframe spacing interval is defined as 96 bit times. The MAC should continue to monitor the medium for collisions while it is transmitting extension bits, and treat any collision that occurs after the threshold ( $\text{slotTime} - \text{headerSize}$ ) as a late collision.

**Test Setup:** Connect the device under test (DUT) to the testing station with the appropriate medium (i.e. unshielded twisted pair (UTP), shielded twisted pair (STP), balanced copper, multi-mode fiber, etc.) and transmit a valid frame to the DUT to ensure that the DUT is functioning properly. See Annex C for suggested test configurations.

#### **Procedure:**

*Part A:*

1. The DUT is instructed to transmit a burst of frames.

#### **Observable Results:**

- a. The testing station should capture the burst transmitted by the DUT. The initial frame in the burst should be either greater than or equal to 512 bytes in length or extended to 512 bytes in length, and each frame within the burst should be separated by 96 carrier extension bits (not including any carrier extension bits transmitted as part of the initial frame).

#### **Possible Problems:**

- The DUT may not support Bursting.

*The University of New Hampshire  
InterOperability Laboratory*

- It may be difficult to force the DUT to transmit bursts of frames due to internal latencies.

*The University of New Hampshire  
InterOperability Laboratory*

**Test #4.7.2 - Burst limit**

**Purpose:** To verify that the device under test (DUT) when in half duplex mode at 1000Mb/s enforces the burstLimit of 64Kb (65536 bits).

**References:**

- [1] IEEE Std 802.3, 2002 Edition - subclauses 4.2.3.2.7, 4.2.3.4, 4.2.8, 4.2.9, 4.4.2.4, and Figure 4-5 (b): BurstTimer Process
- [2] ANNEX A (informative) Table of Acronym Definitions
- [3] ANNEX B (informative) Testing Requirements
- [4] ANNEX C (informative) Suggested Test Setups and Configurations

**Resource Requirements:**

- A testing station capable of transmitting frames with carrier extension and capable of capturing complete frames including carrier extension bits. GMII or PCS access and control by the testing station are ideal.

**Last Modification:** April 8, 2003

**Discussion:** For devices operating in half duplex mode at 1000Mb/s, once a frame has been successfully transmitted (with extension if necessary), the transmitting station may begin transmission of another frame without contending for the medium. All other stations on the network must continue to defer to the transmitting station, provided that it does not allow the medium to assume an idle condition between frames. The transmitting station fills the interframe spacing interval with extension bits, which are readily distinguished from data bits by the receiving stations, and which cause the receiving stations' PHYs to continue asserting carrier sense. The MAC continues to monitor the medium for collisions while it is transmitting extension bits, and it will treat any collision, which occurs after the threshold (slotTime - headerSize) as a late collision.

The burstLimit is defined as 64Kb (65536 bits). Once the burstLimit has been reached, the transmitting station exits burst mode. After the current frame is successfully transmitted, the interframe spacing interval is filled with idle instead of extension bits, thus relinquishing control of the medium. This establishes the maximum carrier event as the burst limit minus one (65535 bits) plus the header size (64 bits), plus maximum frame size (12144 bits).

**Test Setup:** Connect the device under test (DUT) to the testing station with the appropriate medium (i.e. unshielded twisted pair (UTP), shielded twisted pair (STP), balanced copper, multi-mode fiber, etc.) and transmit a valid frame to the DUT to ensure that the DUT is functioning properly. See Annex C for suggested test configurations.

**Procedure:**

*Part A:*

1. The testing station is instructed to transmit five 1518 byte frames, then a 480 + 'n' byte frame and a 1518 byte frame. The initial value of 'n' is 0. The DUT should reply to all of the frames in burst mode.
2. The value 'n' is incremented by 1 and the test frame is retransmitted.
3. Repeat steps 1 and 2 until the last frame is observed to be transmitted outside of the Burst.

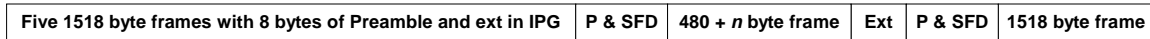

**Figure 4 - 17 Burst limit – Test Case**

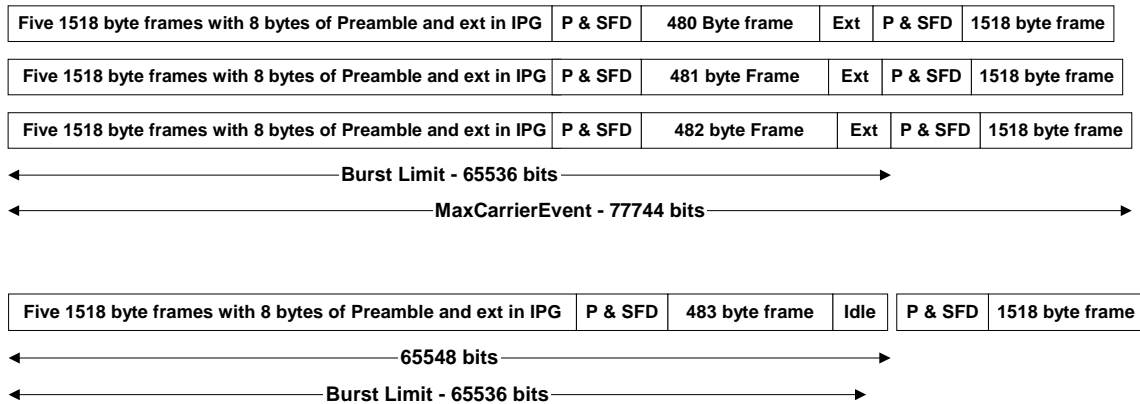

**Figure 4 - 18 Burst limit – Example Test Cases**

**Observable Results:**

- a. The testing station should capture a Burst containing 5 valid 1518 byte frames, each separated by interFrame Spacing Interval consisting of extension bits, the 480 + 'n' byte frame and the final 1518 byte frame. If the value of 'n' is less than 3 then the last two frames should be transmitted as part of the burst. When the value of 'n' is 3 then the final frame should not be transmitted as part of the burst because burstLimit will have expired before the beginning of the final frame. This can be verified by observing the transmission of idle during IFG.

**Possible Problems:**

- The DUT may not support Bursting.
- It may be difficult to force the DUT to transmit bursts of frames due to internal latencies.
- Frames other than 1518 byte frames may have to be used in order to cause some devices to transmit in burst mode.

### **Test #4.7.3 - Receive Frame Bursts**

**Purpose:** To verify that the device under test (DUT) can receive bursts of frames.

#### **References:**

- [1] IEEE Std 802.3, 2002 Edition – subclauses 4.2.3.2.7, 4.2.3.4, 4.2.9, 4.4.2.4; Procedure *PhysicalSignalDecap*, Process *BitReceiver*
- [2] ANNEX A (informative) Table of Acronym Definitions
- [3] ANNEX B (informative) Testing Requirements
- [4] ANNEX C (informative) Suggested Test Setups and Configurations

#### **Resource Requirements:**

- A testing station that is capable of transmitting frames with carrier extension and capable of monitoring traffic from the DUT.

**Last Modification:** April 21, 2003

**Discussion:** In half-duplex mode at 1000 Mb/s, an implementation may optionally transmit a series of frames without relinquishing control of the transmission medium. This mode of operation is referred to as burst mode. The first frame of a burst must always be at least slotTime in length (4096 bits), which may be accomplished through the addition of extension bits. Once this first frame has been successfully transmitted, the transmitting station can begin transmission of another frame without contending for the medium. Other stations on the network will continue to defer to its transmission, provided that the transmitting station does not allow the medium to assume an idle condition between frames. To do this the transmitting station fills the interFrame spacing interval with extension bits in order to maintain control of the medium. The transmitting station is allowed to initiate frame transmission until a specified limit, referred to as burstLimit, is reached. The value of burstLimit is specified in clause 4.4.2.4.

If the first frame within a burst is not slotTime in length (4096 bits) than the BitReceiver process should not set the variable *extending* to false and should discard all frames in the burst until the burst reaches slotTime in length. Once the burst reaches slotTime in length the DUT should finish receiving the current frame and discarded it; all other frames received after the burst reaches slotTime that are at least minFrameSize in length should be accepted.

In full duplex mode and at 1000Mb/s, bursting is not necessary because a device does not have to contend for the medium and, therefore, a device need not attempt to maintain control of the medium by transmitting bursts of frames. If a burst is received while in full duplex mode, the variable *extending* is should always be false. This guarantees that the inner loop of the *BitReceiver* process is exited and that each frame within the burst properly accepted. The *PhysicalSignalDecap* Procedure should then discard the extension between each frame before the frames are de-capsulated. Each valid frame within the burst should, therefore, be accepted, and the burst should not interfere with the reception of other valid frames.

**Test Setup:** Connect the device under test (DUT) to the testing station with the appropriate medium (i.e. unshielded twisted pair (UTP), shielded twisted pair (STP), balanced copper, multi-mode fiber,

*The University of New Hampshire  
InterOperability Laboratory*

etc.) and transmit a valid frame to the DUT to ensure that the DUT is functioning properly. See Annex C for suggested test configurations.

**Procedure:**

*Part A:*

1. The testing station is instructed to transmit burst 1 (as described in Table 4 - 16). The output and statistics of the DUT are observed.
2. The testing station is instructed to repeat step 1 with each test sequence.

**Table 4 - 16 Receive Frame Bursts**

	<b>Test Sequences</b>
<b>1</b>	A 512 byte frame, 12 bytes of extension, and a 64 byte frame
<b>2</b>	A 64 byte frame with 448 bytes of extension, 12 bytes of extension, and a 64 byte frame
<b>3</b>	A 64 byte frame, 12 bytes of extension, and a 64 byte frame
<b>4</b>	A burst consisting of 5 1518 byte frames, a 482 byte frame and another 1518 byte frame

*Part B:*

1. The testing station is instructed to repeat *Part A* with each test sequence preceded and followed by a valid frame.

**Observable Results:**

- a. The DUT should respond to each burst according to the following table.

	<b>Full Duplex</b>	<b>Half Duplex</b>
<b>1</b>	The DUT should accept every frame.	The DUT should accept every frame.
<b>2</b>	The DUT should accept every frame.	The DUT should accept every frame.
<b>3</b>	The DUT should accept every frame.	Both frames should be discarded.
<b>4</b>	The DUT should accept every frame.	The DUT should accept every frame.

**Table 4 - 17 Interpretation of Burst Reception Results**

- b. The reception of the test frame should not interfere with the reception of valid frames.

**Possible Problems:** None

#### **Test #4.7.4 - Reception of Bursts with an initial frame less than slotTime**

**Purpose:** To verify that the device under test (DUT) detects and properly responds to the reception of fragments during a burst.

#### **References:**

- [2] IEEE Std 802.3, 2002 Edition – subclauses 4.2.3.2.7, 4.2.3.4, 4.2.9, 4.4.2.4; Procedure *PhysicalSignalDecap*, Processes *BitReceiver* and *SetExtending*
- [5] ANNEX A (informative) Table of Acronym Definitions
- [6] ANNEX B (informative) Testing Requirements
- [7] ANNEX C (informative) Suggested Test Setups and Configurations

#### **Resource Requirements:**

- A testing station that is capable of transmitting frames with carrier extension and capable of monitoring traffic from the DUT.

**Last Modification:** June 22, 2004

**Discussion:** In half-duplex mode at 1000 Mb/s, an implementation may optionally transmit a series of frames without relinquishing control of the transmission medium for a set period of time. This mode of operation is referred to as burst mode. The first frame of a burst must be at least slotTime in length (4096 bits), which may be accomplished with the addition of extension bits. If the first frame within a burst is not slotTime in length (4096 bits), the *BitReceiver* process will not set the *extending* variable to false and will discard all frames in the burst until the burst reaches slotTime in length. Once slotTime is reached the current frame and all previous frames should be discarded by the DUT, and all other frames that are at least minFrameSize in length should be accepted.

When the first frame in a burst is less than slotTime in length the *BitReceiver* process remains in the inner loop for two reasons:

- 1) In half duplex mode the variable *receiveDataValid* is set to true during the reception of the entire burst (including extension bits),
- 2) The variable *frameFinished* is not set to true until *extending* is false, which only occurs when the burst length reaches slotTime in length.

In addition, each frame received or being received before slotTime is reached will be concatenated onto the previous frames until slotTime is reached and *extending* is set to false.

Each frame within a burst must be separated by extension bits. If the initial frame in a burst is less than slotTime in length these extension bits will be seen as by the receive MAC as extending the length of the initial frame and not as a delineator between each frames. If the initial frame in the burst is (slotTime – 8 bits) to (slotTime – 88) the second frame in the burst may be discarded not because the initial frame is too short but because the interFrameGap between each is frame is too short.

**Test Setup:** Connect the device under test (DUT) to the testing station with the appropriate medium (i.e. unshielded twisted pair (UTP), shielded twisted pair (STP), balanced copper, multi-mode fiber, etc.) and transmit a valid frame to the DUT to ensure that the DUT is functioning properly. See Annex C for suggested test configurations.

**Procedure:**

*Part A:*

1. The testing station is instructed to transmit burst 1 (as described in Table 4 - 18). The output and statistics of the DUT are observed.
2. The testing station is instructed to repeat step 1 with each test sequence.

**Table 4 - 18 Reception of Bursts with an initial frame less than slotTime**

	<b>Test Sequences</b>
<b>1</b>	500 byte frame, 12 bytes of extension, 64 byte frame
<b>2</b>	501 byte frame, 12 bytes of extension, 64 byte frame
<b>3</b>	511 byte frame, 12 bytes of extension, 64 byte frame
<b>4</b>	64 byte frame, 448 bytes of extension, 64 byte frame
<b>5</b>	64 byte frame, 449 bytes of extension, 64 byte frame
<b>6</b>	64 byte frame, 459 bytes of extension, 64 byte frame
<b>7</b>	64 byte frame, 12 bytes of extension, 435 byte frame, 12 bytes of extension, 64 byte frame
<b>8</b>	64 byte frame, 12 bytes of extension, 436 byte frame, 12 bytes of extension, 64 byte frame
<b>9</b>	46 byte frame, 12 bytes of extension, 512 byte frame, 12 bytes of extension, 64 byte frame
<b>10</b>	8 64-byte frames each separated by 12 bytes of extension.

**Observable Results:**

- a. The DUT should accept each frame within the burst that are received in their entirety after the completion of slotTime. These frames also need to be preceded by at least 96 bits of extension (interFrameGap). If the initial frame in a burst is extended to less than slotTime but the addition of interFrameGap (extension bits) extends the carrier event to slotTime the initial frame should be received but the second frame maybe discarded as it will see less than the minimum interFrameGap between the first and the second frame.

	<b>Excepted Results</b>
<b>1</b>	Both frames should be discarded
<b>2</b>	The 501 byte frame should be received and the 64 byte frame should be discarded
<b>3</b>	The 511 byte frame should be received and the 64 byte frame may be received
<b>4</b>	Both frames should be discarded
<b>5</b>	The first 64 byte frame should be received and the second 64 byte frame should be discarded
<b>6</b>	The first 64 byte frame should be received and the second 64 byte frame may be received
<b>7</b>	The first two frames should be discarded while the last 64 byte frame may be received
<b>8</b>	The first two frames should be discarded while the last 64 byte frame should be received



*The University of New Hampshire  
InterOperability Laboratory*

<b>9</b>	The first two frames should be discarded while the last 64 byte frame should be received
<b>10</b>	The last 64 byte frame should be received while all other should be discarded

**Table 4 - 19 Interpretation of Burst Error Reception Results**

**Possible Problems:**

- The extension between the first and second frame in test sequences one through six, the second and third frame in test sequences seven and eight may be considered part of the previous frame (extension) and not interFrameGap. Thus the second or third frame may be discarded or accepted depending on the DUT's ability to accept frames separated by less than minimum interFrameGap.

## **ANNEX A (informative) Table of Acronym Definitions**

(informative)

### **Table of Acronym Definitions**

**Table 4 - 20 Acronym Definitions**

8802-3	ISO/IEC 8802-3 (IEEE Std 802.3)
ANSI	American National Standards Institute
ASIC	application-specific integrated circuit
ASN.1	abstract syntax notation one as defined in ISO/IEC 8824: 1990
MDI, AUI	attachment unit interface
BER	bit error ratio
BPSK	binary phase shift keying
BR	bit rate
BT	bit time
CAT3	Category 3 balanced cable
CAT4	Category 4 balanced cable
CAT5	Category 5 balanced cable
CD0	clocked data zero
CD1	clocked data one
CMIP	common management information protocol as defined in ISO/IEC 9596-1: 1991
CMIS	common management information service as defined in ISO/IEC 9595: 1991
CMOS	complimentary metal oxide semiconductor
CRC	cyclic redundancy check
CRV	code rule violation
CS0	control signal zero
CS1	control signal one
CVH	clocked violation high
CVL	clocked violation low
CW	continuous wave
DA	Destination Address
DTE	data terminal equipment
DUT	Device Under Test
EIA	Electronic Industries Association.
ELFEXT	equal-level far-end crosstalk
EMB	effective modal bandwidth
EMI	Electromagnetic Interference
EPD	End_of_Packet Delimiter
ESD	end of stream delimiter
FCS	Frame Check Sequence
FC-PH	Fibre Channel - Physical and Signaling Interface
FOTP	fiber optic test procedure
GMII	Gigabit Media Independent Interface
IEC	International Electrotechnical Commission
IFG	interFrameGap

*The University of New Hampshire  
InterOperability Laboratory*

IFSP1	inter-frame spacing part 1
IFSP2	inter-frame spacing part 2
IH	intermediate hub
IRL	inter-repeater link
ISI penalty	intersymbol interference penalty
ISO	International Organization for Standardization
LAN	local area network
LLC	logical link control
LSDV	link segment delay value
MAC	medium access control
MAU	medium attachment unit
MC	message code
MDELNEXT	multiple-disturber equal-level far-end crosstalk
MDNEXT	multiple-disturber far-end crosstalk
MDI	medium dependent interface
MDNEXT	multiple-disturber near-end crosstalk
MIB	management information base
MII	media independent interface
MMF	multimode fiber
MP	message page
NEXT	near-end crosstalk
NLP	normal link pulse
NPA	next page algorithm
NRZI	non return to zero and invert on ones
OFL	overfilled launch
OFSTP	optical fiber system test procedure
PCS	physical coding sublayer
PDV	path delay value
PHY	Physical Layer entity sublayer
PICS	protocol implementation conformance statement
PLS	physical signaling sublayer
PMA	physical medium attachment
PMD	physical medium dependent
PMI	physical medium independent
PPD	peak-to-peak differential
PVV	path variability value
RD	running disparity
RFI	Radio Frequency Interference
RIN	relative intensity noise
ROFL	radial overfilled launch
RS	reconciliation sublayer
SA	Source Address
SDV	segment delay value
SFD	start-of-frame delimiter
SMF	singlemode fiber
SPD	Start_of_Packet Delimiter
SR	symbol rate
SSD	start-of-stream delimiter

*The University of New Hampshire  
InterOperability Laboratory*

ST	symbol time
STE	station management entity
STP	shielded twisted pair (copper)
SVV	segment variability value
TDR	Time Domain Reflectometer
TIA	Telecommunications Industry Association
UCT	unconditional transition
UP	unformatted page
UTP	unshielded twisted pair
WCMB	worst case modal bandwidth

## **ANNEX B (informative) Testing Requirements**

(informative)

### **Testing requirements.**

A testing station that implements transmit (encoding) and receive (decoding) functions specific to the Ethernet PHY in use by the device under test (DUT). MDI, AUI, MII, GMII or PCS access and or control by the testing station are ideal.

### **Typical Testing Stations:**

Arbitrary Waveform Generator  
Logic Analyzer with Pattern Generator  
Symbol Generating Device  
Sniffer, traffic generator (i.e. SmartBits...)

## ANNEX C (informative) Suggested Test Setups and Configurations

(informative)

### Suggested Test Setups and Configurations

The following test setups are specific to certain physical layers.

The setup described in Figure 4 - 19 can be used to test 10Base-T devices. Observations can be used to monitor the TD and RD circuits with differential probes placed at the same point on the cable.

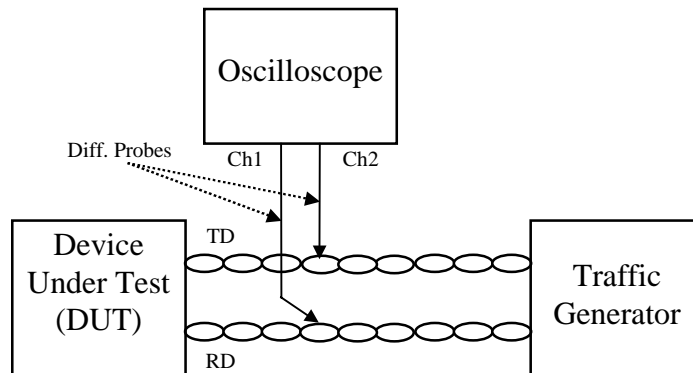

Figure 4 - 19 Test Setup for 10BASE-T Device

The setup described in Figure 4 - 20 and Figure 4 - 21 can be used to test 100BASE-X devices.

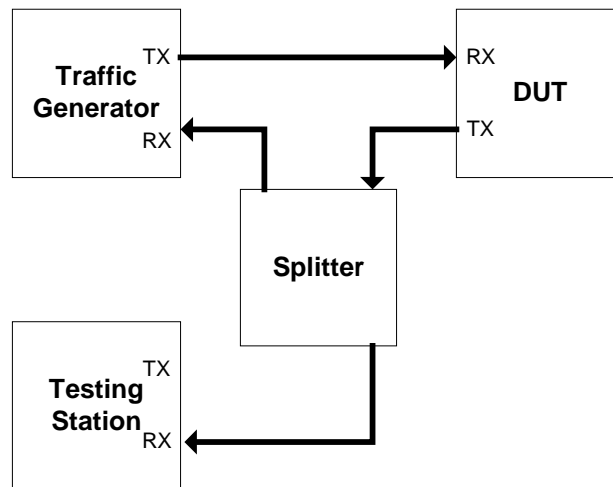
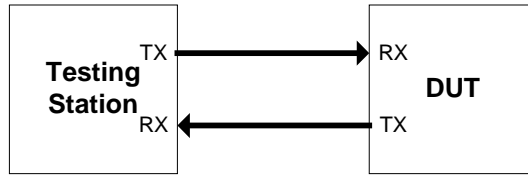
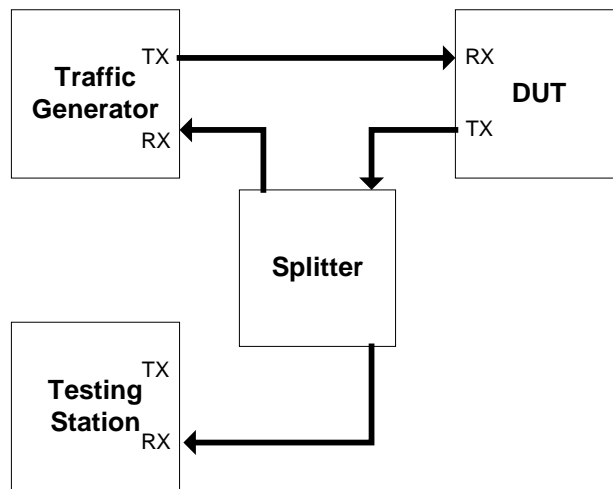

Figure 4 - 20 Test Setup #1 for 100BASE-X Devices

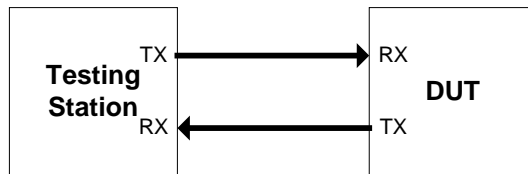

**Figure 4 - 21 Test Setup #2 for 100BASE-X Devices**

The setup described in Figure 4 - 22 and Figure 4 - 23 can be used to test 1000BASE-X devices. The DUT may be connected directly to the testing station, or the testing station may be set up to monitor the frames transmitted by the DUT a traffic generator.

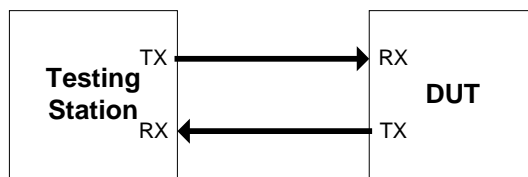

**Figure 4 - 22 Test Setup #1 for 1000BASE-X Devices**



**Figure 4 - 23 Test Setup #2 for 1000BASE-X Devices**

The setup described in Figure 4 - 24 can be used to test 1000BASE-T devices.



**Figure 4 - 24 Test Setup for 1000BASE-T Devices**

## ANNEX D Stressing the device under test (DUT)

Under most conditions a device will function properly. A device is more likely to malfunction while operating under stressful conditions; this may be accomplished using the following methods:

### Using PAUSE frames

Send the DUT one or more pause frames while it is attempting to reply to or forward multiple frames. The device's buffers should fill and, after `pause_time` has expired, the device should reply to or forward frames at or near line rate.

### Forwarding large numbers of frames through a switch

Connect the DUT to two traffic generators and the testing station (as illustrated below). Each port on the DUT should have a full duplex link and each should be configured to link at the same speed (10Mb/s, 100Mb/s or 1000Mb/s). Transmit frames at line rate from the traffic generators so that the DUT attempts to forward them to the testing station (put the individual MAC address of the testing station in the destination address field of the frames being transmitted by the traffic generators).

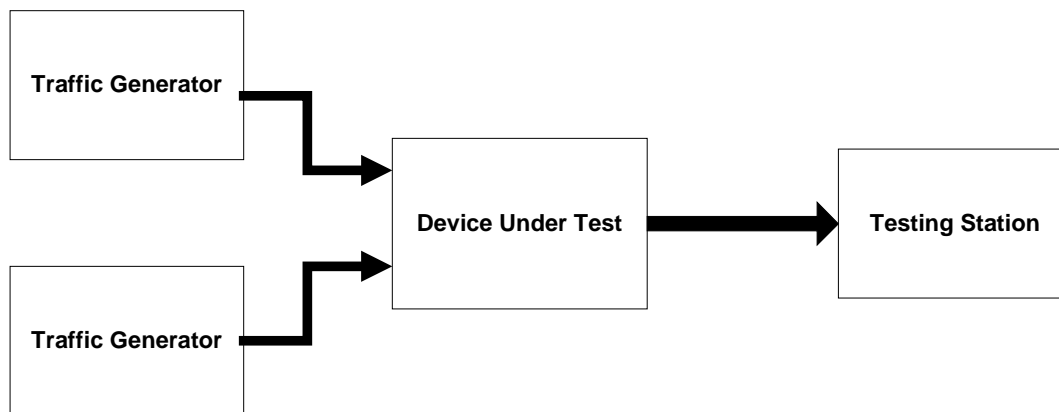

Figure 4 - 25 Stressing a Switch

### Using Backpressure

Connect the DUT to the testing station so that a half duplex link of the appropriate speed is established. The DUT is instructed to transmit a large number of frames. The testing station is instructed to cause a collision during each frame so that the DUT is unable to successfully transmit any frames, thus causing the DUT's buffers to fill. The testing station is then instructed to cease causing collisions and the DUT should transmit each frame at or near line rate.